

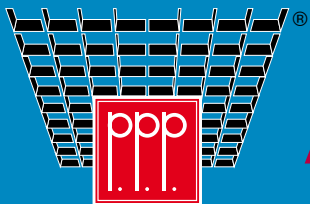

***FROM VENICE TO THE FUTURE***

***SOLUZIONI MODULARI OPEN CELL PER CONTROSOFFITTI***

***OPEN CELL SUSPENDED CEILING***



# SOLUZIONI MODULARI OPEN CELL PER CONTROSOFFITTI

Linee geometriche pure che si rincorrono e intersecano armoniosamente disegnando sul soffitto un ordinato orizzonte di luce: **PPP, leader da oltre 60 anni nella lavorazione delle materie plastiche**, propone una vasta gamma di **controsoffitti grigliati** (open cell) realizzati in ABS e ASA/PC, materiali termoplastici di ultima generazione, variegati nelle maglie, pannellature, nei colori, nelle finiture speciali metallizzate.

I grigliati sono estremamente versatili e adattabili a tutte le tendenze ed ai vari contesti di arredamento, siano essi classici, moderni, tecnologici, eleganti o funzionali. Offrono inoltre, **svariate possibilità di personalizzazione**.

**Lo speciale sistema di aggancio a scatto** tra i pannelli e la pendinatura senza strutture rendono la superficie perfettamente uniforme e ispezionabile, la posa è semplice, il risultato del montaggio è sempre perfetto e durevole nel tempo. Adatti sia per piccoli che per grandi ambienti quali locali commerciali, hall, stand fieristici, sale riunioni, ristorazione, uffici, ecc.

In aggiunta ai test già in passato superati presso paesi Ue ed extra UE, **tutti i modelli sono certificati CE secondo la norma EN13964 di recente applicazione**, non temono le temperature ambientali elevate, nebbie saline, umidità, nè i climi rigidi. Applicazioni di prestigio si trovano in resort caraibici, aeroporti, uffici, show room, centri congressi, hotel, impianti sportivi, hall, banche, ristoranti e centri commerciali.



# OPEN CELL SUSPENDED CEILING

Geometric lines which run and cross the ceiling harmoniously, designing an ordered surface of light: **PPP**, leader for over 60 years in the working of plastics, offers a great range of open cell system ceilings, made in ABS and ASA/PC, ultimate thermoplastic materials, with varied mesh sizes, panels, colors and special metallic finishes.

The ceilings are extremely versatile and adaptable to all uses and styles, be they classic, modern, hi-tech, elegant or purely functional. **The possibilities are endless.**

**The special interlocking panel design** and the structure free hanging system ensure a perfectly uniform (and accessible) surface. Installation is simple, providing an always perfect and long lasting ceiling. Suitable for both small and large spaces such as retail outlets, halls, trade fairs stands, meeeting rooms, restaurants, offices, etc.

In addition to the test already passed within EU and abroad, **all models are now also fire-rated CE according to EN 13964**, resistant to both high and very low ambient temperature, salty atmosphere and humidity. Successful and prestigious use of our ceilings can be found in caribbean resorts, airports, offices, show-rooms, meeting rooms, congress centers, hotels, sporting venues, banks, restaurants and shopping malls.

## INDICE INDEX

**129**  
pag. 4



**137**  
pag. 8



**140**  
pag. 10



**141**  
pag. 14



**142**  
pag. 16



**158**  
pag. 20



**159**  
pag. 22



**169**  
pag. 24



**170**  
pag. 26



**190**  
pag. 28



**202**  
Luxcolor  
pag. 30



**202**  
Luxcolor  
Jolly  
pag. 30



**Quadrilux**  
pag. 32



**Colors  
and finishes**  
pag. 32



Controsoffitto open cell in ABS normale o in ASA/PC autoestinguente EN13964 (cod. FR). Colore di serie bianco o nero. A richiesta in ABS colorato o in PMMA trasparente colorato (quantitativi da concordare). Finitura speciale: metallizzato argento e silver satinato.

Open cell system false-ceiling in high quality ABS or self extinguishing ASA/PC according to EN13964 (FR code). Standard colors: white or black. By request available: coloured ABS or transparent PMMA (quantity to be agreed). Special finish: metallized silver and silver satin.

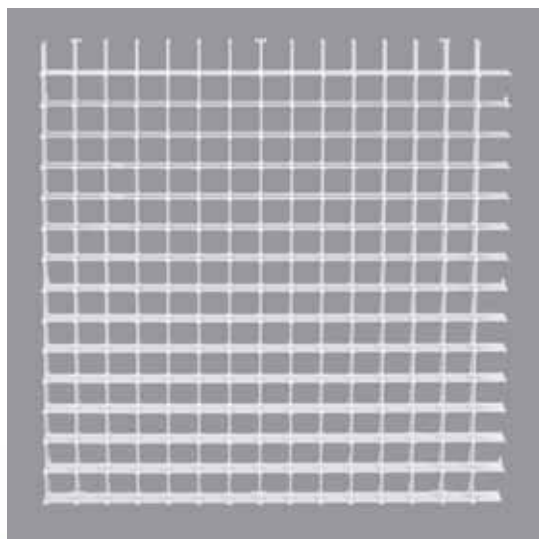

Versione ABS		129/60	129/40	129/M	129/S	129/T
• Materiale / Material • Finitura / Finish		ABS	ABS	ABS metallized	ABS silver satin	PMMA inc.
• Dimensioni maglia • Mesh size	mm.	40x40	40x40	40x40	40x40	40x40
• Dimensioni pannello • Panel size	mm.	600x600	400x400	400x400	400x400	400x400
• Altezza pannello • Panel height	mm.	30	30	30	30	30
• Peso al mq. • Weight per sq.m.	kg.	3,25	3,25	3,25	3,25	3,25
• Pannelli per cartone • Panels per carton	n°	10	19	19	19	19
• Mq. per cartone • Sq.m. per carton	mq.	3,6	3,04	3,04	3,04	3,04
• Dimensioni cartone • Carton size	cm.	62x62x30	42x42x60	42x42x60	42x42x60	42x42x60
• Peso per cartone • Weight per carton	kg.	13,5	11,2	11,2	11,2	11,2
• Euroclasse • Euroclass	UNI EN13964	F	F	F	F	F
<b>Versione FR autoestinguente</b>			<b>129/FR/40</b>	<b>129/FRM</b>	<b>129/FRS</b>	
• Materiale / Material • Finitura / Finish			ASA/PC	ASA/PC metallized	ASA/PC silver satin	
• Euroclasse • Euroclass	UNI EN13964		B s2d0	C s2d0	B s2d0	



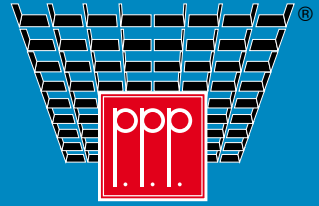

CE



P.P.P.  
1 2 9



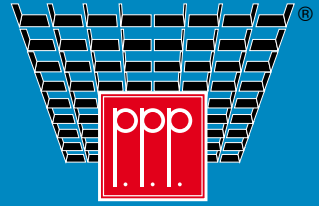

CE

Controsoffitto open cell in ABS normale o in ASA/PC autoestinguente EN13964 (cod. FR). Colore di serie bianco o nero. A richiesta in ABS colorato (quantitativi da concordare).

Open cell system false-ceiling in high quality ABS or self extinguishing ASA/PC according to EN13964 (FR code). Standard colors: white or black. By request available: coloured ABS (quantity to be agreed).

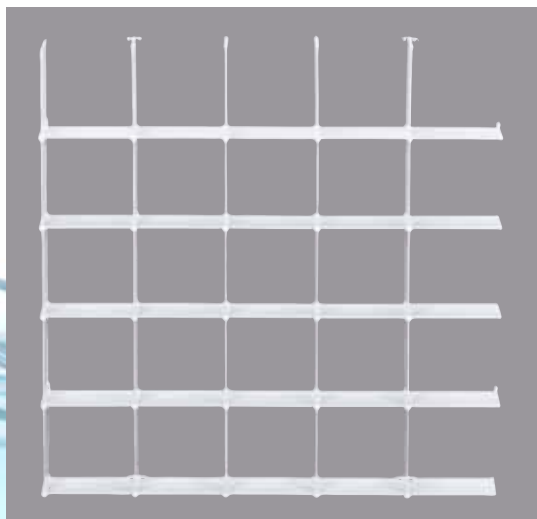

Versione ABS		137
• Materiale / Material • Finitura / Finish		ABS
• Dimensioni maglia • Mesh size	mm.	80x80
• Dimensioni pannello • Panel size	mm.	400x400
• Altezza pannello • Panel height	mm.	40
• Peso al mq. • Weight per sq.m.	kg.	2,2
• Pannelli per cartone • Panels per carton	n°	14
• Mq. per cartone • Sq.m. per carton	mq.	2,24
• Dimensioni cartone • Carton size	cm.	42x42x60
• Peso per cartone • Weight per carton	kg.	6
• Euroclasse • Euroclass	UNI EN13964	F
Versione FR autoestinguente		137/FR
• Materiale / Material • Finitura / Finish		ASA/PC
• Euroclasse • Euroclass	UNI EN13964	B s1d0





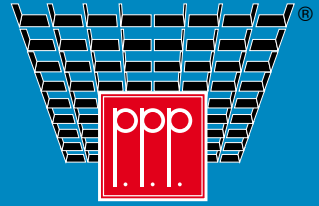

CE

Controsoffitto open cell in ABS normale o in ASA/PC autoestinguente EN13964 (cod. FR). Colore di serie bianco o nero. A richiesta in ABS colorato o in PMMA trasparente colorato (quantitativi da concordare). Finitura speciale: metallizzato argento e silver satinato.

Open cell system false-ceiling in high quality ABS or self extinguishing ASA/PC according to EN13964 (FR code). Standard colors: white or black. By request available: coloured ABS or transparent PMMA (quantity to be agreed). Special finish: metallized silver and silver satin.

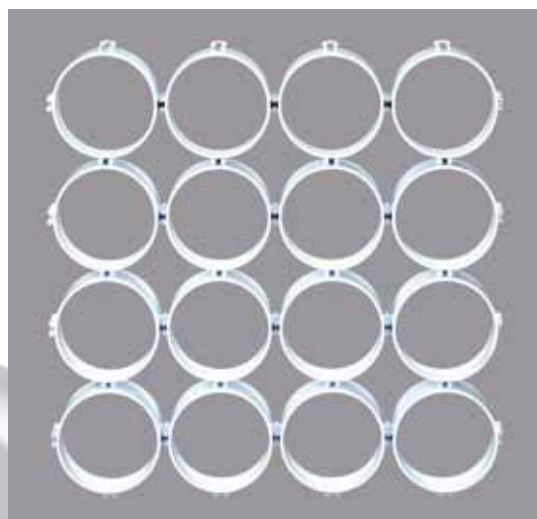

<b>Versione ABS</b>		<b>140</b>	<b>140/M</b>	<b>140/S</b>	<b>140/T</b>
• Materiale / Material • Finitura / Finish		ABS	ABS metallized	ABS silver satin	PMMA
• Dimensioni maglia • Mesh size	mm.	Diam. 120	Diam. 120	Diam. 120	Diam. 120
• Dimensioni pannello • Panel size	mm.	510x510	510x510	510x510	510x510
• Altezza pannello • Panel height	mm.	50	50	50	50
• Peso al mq. • Weight per sq.m.	kg.	3,6	3,4	3,6	3,6
• Pannelli per cartone • Panels per carton	n°	13	13	13	13
• Mq. per cartone • Sq.m. per carton	mq.	3,38	3,38	3,38	3,38
• Dimensioni cartone • Carton size	cm.	53x53x68	53x53x68	53x53x68	53x53x68
• Peso per cartone • Weight per carton	kg.	14,5	14	14	14,5
• Euroclasse • Euroclass	UNI EN13964	F	F	F	F
<b>Versione FR autoestinguente</b>		<b>140/FR</b>	<b>140/FRM</b>	<b>140/FRS</b>	
• Materiale / Material • Finitura / Finish		ASA/PC	ASA/PC metallized	ASA/PC silver satin	
• Euroclasse • Euroclass	UNI EN13964	B s2d0	C s2d0	B s2d0	



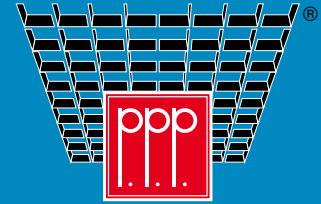

CE

P.P.P.  
140



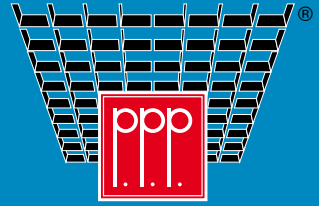

CE

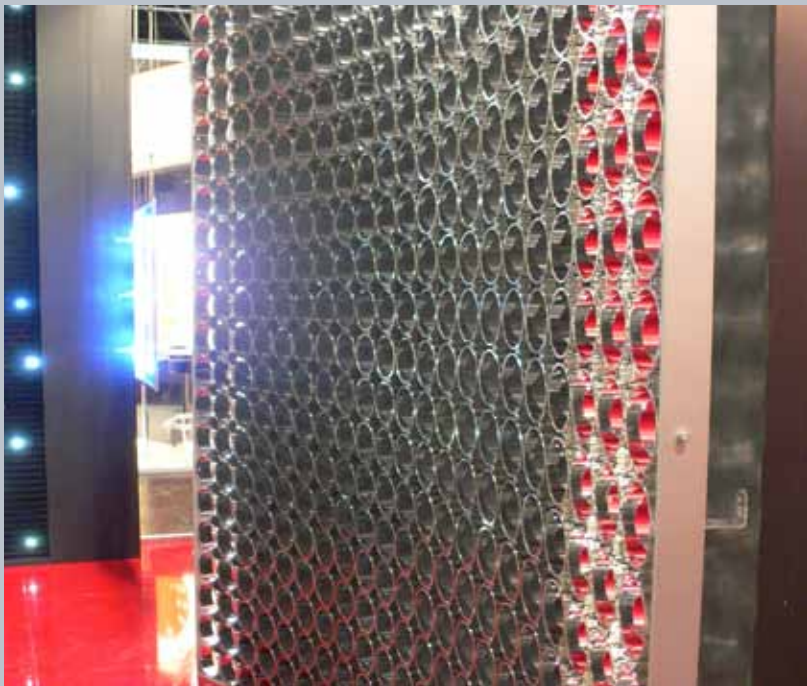

Controsoffitto open cell in ABS normale o in ASA/PC autoestinguente EN13964 (cod. FR). Colore di serie bianco o nero. A richiesta in ABS colorato (quantitativi da concordare).

Open cell system false-ceiling in high quality ABS or self extinguishing ASA/PC according to EN13964 (FR code). Standard colors: white or black. By request available: coloured ABS (quantity to be agreed).

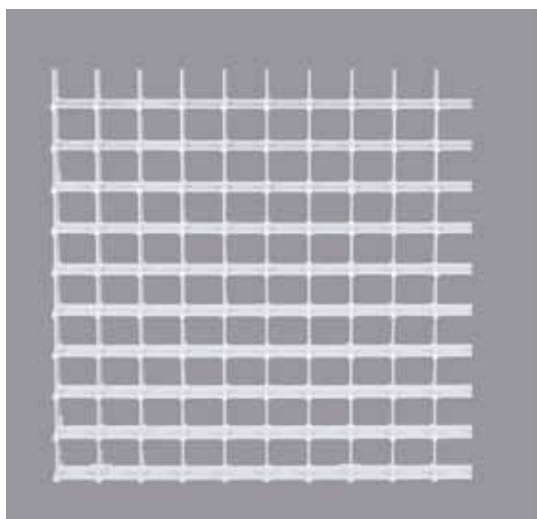

<b>Versione ABS</b>		<b>141</b>
• Materiale / Material • Finitura / Finish		ABS
• Dimensioni maglia • Mesh size	mm.	60x60
• Dimensioni pannello • Panel size	mm.	600x600
• Altezza pannello • Panel height	mm.	40
• Peso al mq. • Weight per sq.m.	kg.	3,2
• Pannelli per cartone • Panels per carton	n°	10
• Mq. per cartone • Sq.m. per carton	mq.	3,6
• Dimensioni cartone • Carton size	cm.	62x62x40
• Peso per cartone • Weight per carton	kg.	12,95
• Euroclasse • Euroclass	UNI EN13964	F
<b>Versione FR autoestinguente</b>		<b>141/FR</b>
• Materiale / Material • Finitura / Finish		ASA/PC
• Euroclasse • Euroclass	UNI EN13964	B s2d0



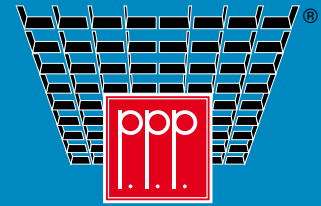

CE

Controsoffitto open cell in ABS normale o in ASA/PC autoestinguente EN13964 (cod. FR). Colore di serie bianco o nero. A richiesta in ABS colorato o in PMMA trasparente colorato (quantitativi da concordare). Finitura speciale: metallizzato argento e silver satinato.

Open cell system false-ceiling in high quality ABS or self extinguishing ASA/PC according to EN13964 (FR code). Standard colors: white or black. By request available: coloured ABS or transparent PMMA (quantity to be agreed). Special finish: metallized silver and silver satin.

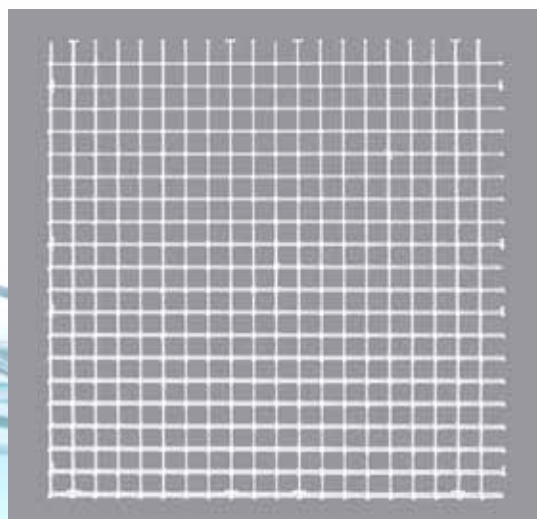

Versione ABS		142/40	142/20	142/M	142/S	142/T
• Materiale / Material • Finitura / Finish		ABS	ABS	ABS metallized	ABS silver satin	PMMA
• Dimensioni maglia • Mesh size	mm.	20x20	20x20	20x20	20x20	20x20
• Dimensioni pannello • Panel size	mm.	400x400	200x200	400x400	400x400	200x200
• Altezza pannello • Panel height	mm.	15	15	15	15	15
• Peso al mq. • Weight per sq.m.	kg.	2,4	2,4	2,4	2,4	2,4
• Pannelli per cartone • Panels per carton	n°	38	76	36	36	76
• Mq. per cartone • Sq.m. per carton	mq.	6,08	3,04	5,76	5,76	3,04
• Dimensioni cartone • Carton size	cm.	42x42x60	42x42x30	42x42x60	42x42x60	42x42x30
• Peso per cartone • Weight per carton	kg.	15,4	8	14,1	14,1	8,1
• Euroclasse • Euroclass	UNI EN13964	F	F	F	F	F
<b>Versione FR autoestinguente</b>		<b>142/FR/40</b>	<b>142/FR/20</b>	<b>142/FRM</b>	<b>142/FRS</b>	
• Materiale / Material • Finitura / Finish		ASA/PC	ASA/PC	ASA/PC metallized	ASA/PC silver satin	
• Euroclasse • Euroclass	UNI EN13964	B s1d0	B s1d0	B s2d0	B s2d0	





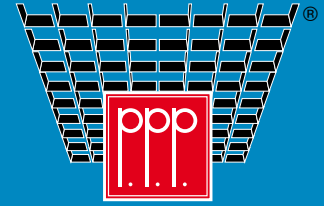

CE



Controsoffitto open cell in ABS normale. Colore di serie bianco o nero. A richiesta in ABS colorato (quantitativi da concordare). Non disponibile in versione autoestinguente. Accessori opzionali: art 158/L elemento a "L" per tamponamento lato non a vista (per l'uso come parete divisoria).

Open cell system false-ceiling in high quality ABS. Standard colors: white or black. By request available: coloured ABS (quantity to be agreed). FR self extinguishing version not available. An "L" shaped element is available to close the rear panel for vertical partition walls use (Art.Code 158/L).

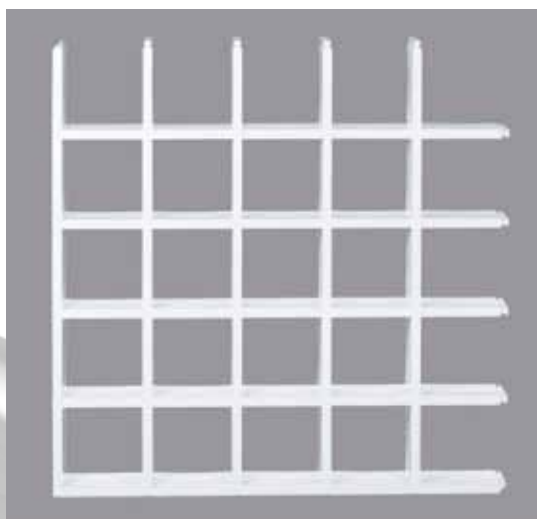

Versione ABS		158	158/L
• Materiale / Material • Finitura / Finish		ABS	ABS
• Dimensioni maglia • Mesh size	mm.	120x120	120x120
• Dimensioni pannello • Panel size	mm.	600x600	
• Altezza pannello • Panel height	mm.	60	
• Peso al mq. • Weight per sq.m.	kg.	4,1	
• Pannelli per cartone • Panels per carton	n°	10	
• Mq. per cartone • Sq.m. per carton	mq.	3,6	
• Dimensioni cartone • Carton size	cm.	63X63X62	
• Peso per cartone • Weight per carton	kg.	17,6	
• Euroclasse • Euroclass	UNI EN13964	F	

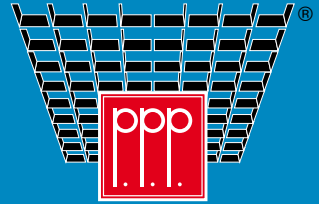

CE

Controsoffitto open cell in ABS normale o in ASA/PC autoestinguente EN13964 (cod. FR). Colore di serie bianco o nero. A richiesta in ABS colorato (quantitativi da concordare) Finitura speciale: metallizzato argento e silver satinato.

Open cell system false-ceiling in high quality ABS or self extinguishing ASA/PC according to EN13964 (FR code). Standard colors: white or black. By request available: coloured ABS (quantity to be agreed). Special finish: metallized silver and silver satin.

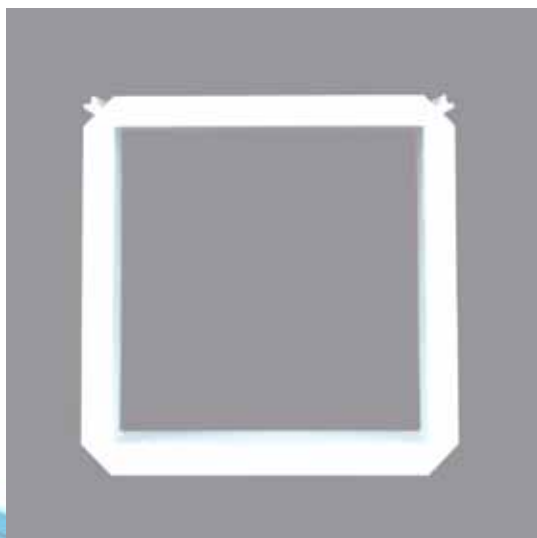

<b>Versione ABS</b>		<b>159</b>	<b>159/M</b>
• Materiale / Material • Finitura / Finish		ABS	ABS metallized
• Dimensioni maglia • Mesh size	mm.	200x200	200x200
• Dimensioni pannello • Panel size	mm.	200x200	200x200
• Altezza pannello • Panel height	mm.	70	70
• Peso al mq. • Weight per sq.m.	kg.	3,6	3,6
• Pannelli per cartone • Panels per carton	n°	42	42
• Mq. per cartone • Sq.m. per carton	mq.	3,36	3,36
• Dimensioni cartone • Carton size	cm.	66x45x51	66x45x51
• Peso per cartone • Weight per carton	kg.	14,1	14,1
• Euroclasse • Euroclass	UNI EN13964	F	F
<b>Versione FR autoestinguente</b>		<b>159/FR</b>	
• Materiale / Material • Finitura / Finish		ASA/PC	
• Euroclasse • Euroclass	UNI EN13964	B s2d0	



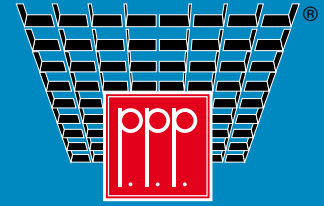

CE

Controsoffitto open cell in ABS normale o in ASA/PC autoestinguente EN13964 (cod. FR). Colore di serie bianco o nero. A richiesta in ABS colorato o in PMMA trasparente colorato (quantitativi da concordare). Finitura speciale: metallizzato argento e silver satinato.

Open cell system false-ceiling in high quality ABS or self extinguishing ASA/PC according to EN13964 (FR code). Standard colors: white or black. By request available: coloured ABS or transparent PMMA (quantity to be agreed). Special finish: metallized silver and silver satin.

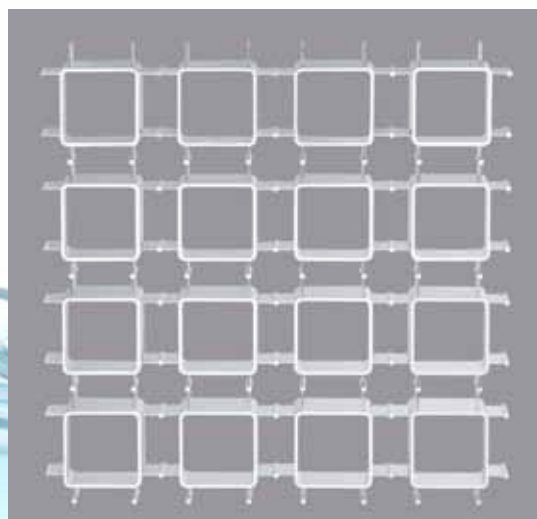

<b>Versione ABS</b>		<b>169</b>	<b>169/M</b>	<b>169/S</b>	<b>169/T</b>
• Materiale / Material • Finitura / Finish		ABS	ABS metallized	ABS silver satin	PMMA
• Dimensioni maglia • Mesh size	mm.	100x100	100x100	100x100	100x100
• Dimensioni pannello • Panel size	mm.	600x600	600x600	600x600	600x600
• Altezza pannello • Panel height	mm.	60	60	60	60
• Peso al mq. • Weight per sq.m.	kg.	3	2,8	3	3
• Pannelli per cartone • Panels per carton	n°	10	10	10	10
• Mq. per cartone • Sq.m. per carton	mq.	3,6	3,6	3,6	3,6
• Dimensioni cartone • Carton size	cm.	63x63x62	63x63x62	63x63x62	63x63x62
• Peso per cartone • Weight per carton	kg.	14	12,8	12,8	14
• Euroclasse • Euroclass	UNI EN13964	F	F	F	F
<b>Versione FR autoestinguente</b>		<b>169/FR</b>	<b>169/FRM</b>	<b>169/FRS</b>	
• Materiale / Material • Finitura / Finish		ASA/PC	ASA/PC metallized	ASA/PC silver satin	
• Euroclasse • Euroclass	UNI EN13964	B s2d0	C s2d0	B s2d0	



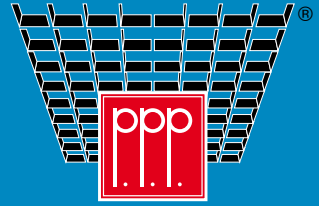

CE



Controsoffitto open cell in ABS normale o in ASA/PC autoestinguente EN13964 (cod. FR). Colore di serie bianco o nero. A richiesta in ABS colorato (quantitativi da concordare). Finitura speciale: metallizzato argento e silver satinato.

Open cell system false-ceiling in high quality ABS or self extinguishing ASA/PC according to EN13964 (FR code). Standard colors: white or black. By request available: coloured ABS (quantity to be agreed). Special finish: metallized silver and silver satin.

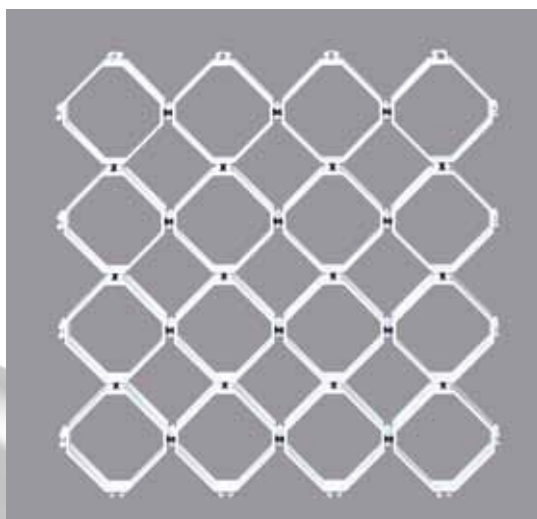

<b>Versione ABS</b>		<b>170</b>	<b>170/M</b>	<b>170/S</b>
• Materiale / Material • Finitura / Finish		ABS	ABS metallized	ABS silver satin
• Dimensioni maglia • Mesh size	mm.	100x100	100x100	100x100
• Dimensioni pannello • Panel size	mm.	510x510	510x510	510x510
• Altezza pannello • Panel height	mm.	50	50	50
• Peso al mq. • Weight per sq.m.	kg.	3,6	3,6	3,6
• Pannelli per cartone • Panels per carton	n°	13	13	13
• Mq. per cartone • Sq.m. per carton	mq.	3,38	3,38	3,38
• Dimensioni cartone • Carton size	cm.	53x53x68	53x53x68	53x53x68
• Peso per cartone • Weight per carton	kg.	14	13	13
• Euroclasse • Euroclass	UNI EN13964	F	F	F
<b>Versione FR autoestinguente</b>		<b>170/FR</b>	<b>170/FRM</b>	<b>170/FRS</b>
• Materiale / Material • Finitura / Finish		ASA/PC	ASA/PC metallized	ASA/PC silver satin
• Euroclasse • Euroclass	UNI EN13964	B s2d0	C s2d0	B s2d0





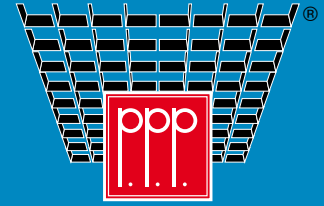

CE

Controsoffitto open cell in ABS normale o in ASA/PC autoestinguente EN13964 (cod. FR). Colore di serie bianco o nero. A richiesta in ABS colorato (quantitativi da concordare). Finitura speciale: metallizzato argento e silver satinato.

Open cell system false-ceiling in high quality ABS or self extinguishing ASA/PC according to EN13964 (FR code). Standard colors: white or black. By request available: coloured ABS (quantity to be agreed). Special finish: metallized silver and silver satin.

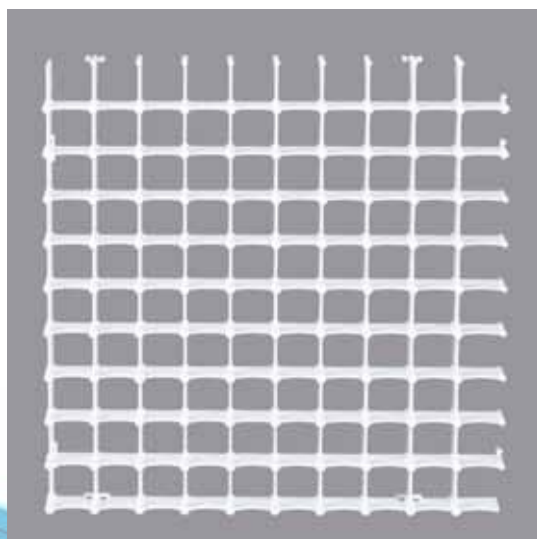

<b>Versione ABS</b>		<b>190</b>	<b>190/M</b>	<b>190/S</b>
• Materiale / Material • Finitura / Finish		ABS	ABS metallized	ABS silver satin
• Dimensioni maglia • Mesh size	mm.	20x20	20x20	20x20
• Dimensioni pannello • Panel size	mm.	200x200	400x400	400x400
• Altezza pannello • Panel height	mm.	15	15	15
• Peso al mq. • Weight per sq.m.	kg.	2,2	2,2	2,2
• Pannelli per cartone • Panels per carton	n°	76	13	19
• Mq. per cartone • Sq.m. per carton	mq.	3,04	3,04	3,04
• Dimensioni cartone • Carton size	cm.	42x42x30	42x42x30	42x42x30
• Peso per cartone • Weight per carton	kg.	7,65	7,65	7,65
• Euroclasse • Euroclass	UNI EN13964	F	F	F
<b>Versione FR autoestinguente</b>		<b>190/FR</b>	<b>190/FRM</b>	<b>190/FRS</b>
• Materiale / Material • Finitura / Finish		ASA/PC	ASA/PC metallized	ASA/PC silver satin
• Euroclasse • Euroclass	UNI EN13964	B s1d0	C s2d0	B s2d0





CE

Controsoffitto open cell in ABS normale. Colore di serie bianco o nero. A richiesta in ABS colorato o in PMMA trasparente colorato [quantitativi da concordare]. Finitura speciale: metallizzato argento e silver satinato.

Open cell system false-ceiling in high quality ABS. Standard colors: white or black. By request available: coloured ABS or transparent PMMA [quantity to be agreed]. Special finish: metallized silver and silver satin.

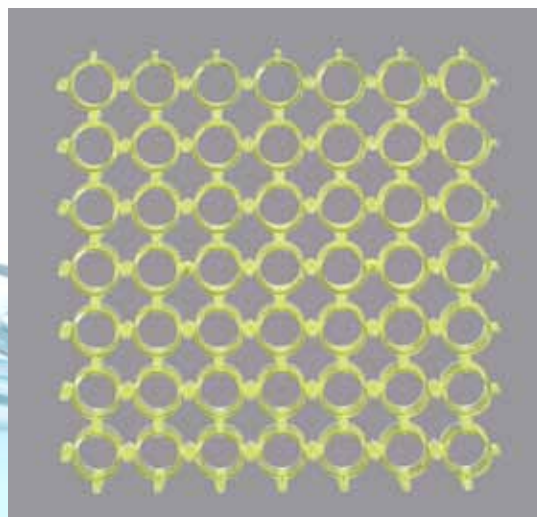

Versione ABS		202/20	202/M	202/I
• Materiale / Material • Finitura / Finish		PMMA o ABS	ABS metallized	PMMA
• Dimensioni maglia • Mesh size	mm.	diam. 21	diam. 21	diam. 21
• Dimensioni pannello • Panel size	mm.	197x197	197x197	single element
• Altezza pannello • Panel height	mm.	20	20	20
• Peso al mq. • Weight per sq.m.	kg.	5	4,8	5
• Pannelli per cartone • Panels per carton	n°	80	72	500 pz.
• Mq. per cartone • Sq.m. per carton	mq.	3,1	2,8	
• Dimensioni cartone • Carton size	cm.	41x41x40	41x41x40	
• Peso per cartone • Weight per carton	kg.	13,5	11,2	
• Euroclasse • Euroclass	UNI EN13964	F	F	F

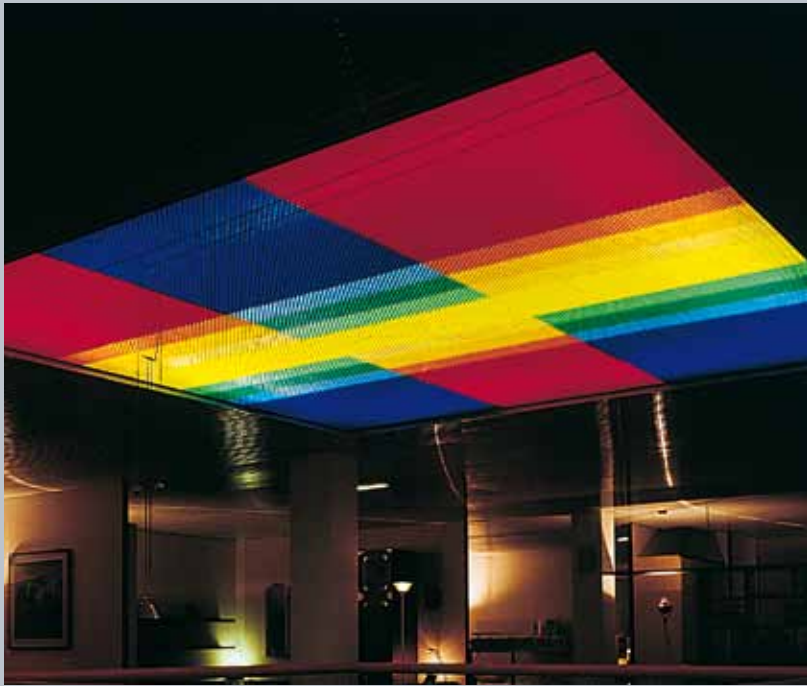

Jolly



- L'elemento singolo Jolly consente di realizzare pannelli personalizzati per decori e dimensioni. I pannelli che si ottengono sono compatibili nell'aggancio con l' art. 202, per completare grandi superfici.

- The Jolly Single element allow to create "custom made" panels. The obtained panel can be installed together with the 202 panel to fit out larger surfaces.



# P.P.P. Quadrilux

Per gli art.129 e 142 sono disponibili tessere ad incastro in 10 colori per creare decori, scritte, loghi, interventi con tecnica a mosaico. L'effetto estetico e' originale e unico; le decorazioni sono facilmente realizzabili.

Quadrilux tesserae allows to create every kind of decoration on grill panels art.142 or 129, using mosaic style. For great decoration ideas and eye-catching surfaces. Easy to insert/remove from the panels.



Versione ABS o PMMA	142/Q	129/Q
<ul style="list-style-type: none"><li>• Per grigliato art.</li><li>• For ceiling art.</li></ul>	142	129
<ul style="list-style-type: none"><li>• Dimensioni tessera mm.</li><li>• Tesserae size mm.</li></ul>	20x20	40x40
<ul style="list-style-type: none"><li>• N° pezzi per conf/colore</li><li>• Pcs per carton/color</li></ul>	200	100



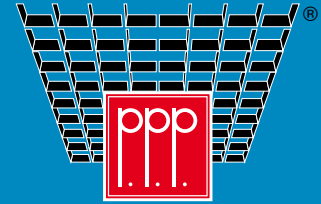

CE

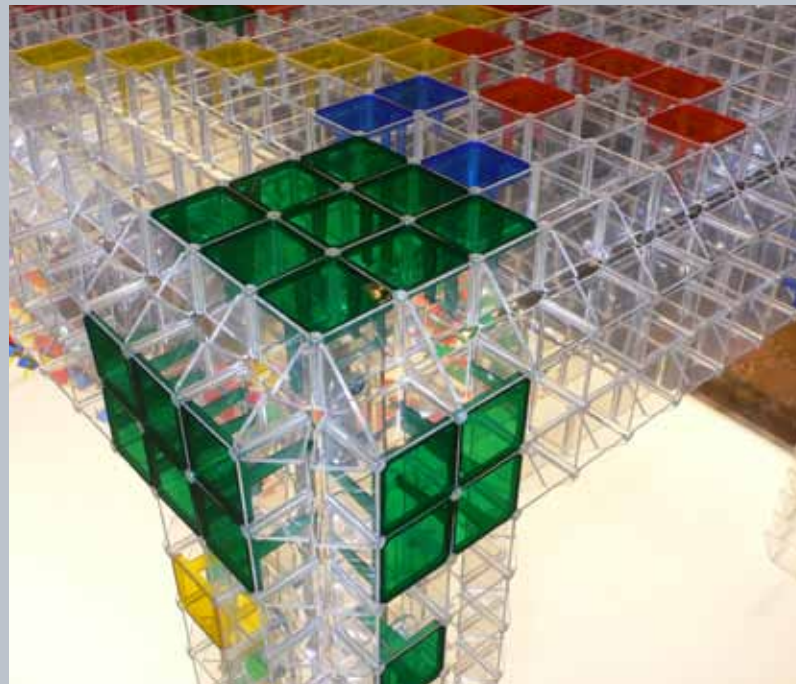

◀ Gridspace by  
Andy Martin Studio  
Fuori Salone Milano

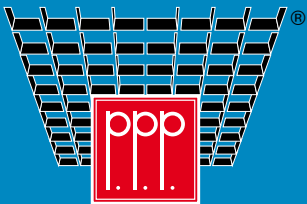

## Colori e finiture

- Colori standard ABS: tutta la gamma è disponibile di serie nei colori bianco o nero, sia nella versione normale che omologata Autoestinguente secondo EN 13964 Classe B s2d0. A richiesta e per quantità da concordare, i grigliati vengono realizzati nei colori ABS (vedi collana).
- Standard ABS colours: the whole P.P.P. ceiling panel range is available in black and white (normal or self-extinguishing - EN 13964 Class B s2d0). On request, and for quantities to be agreed, custom ABS colours are available.

- Colori trasparenti: per ambientazioni spettacolari e luminose, i grigliati art.142,129, 202, sono stampabili in metacrilato (PMMA) in splendide tonalità trasparenti e colorate.
- Transparent colours: for special, spectacular and luminous effects, panels 129, 142 e 202 are mouldable in transparent and coloured Metacrylate (PMMA).

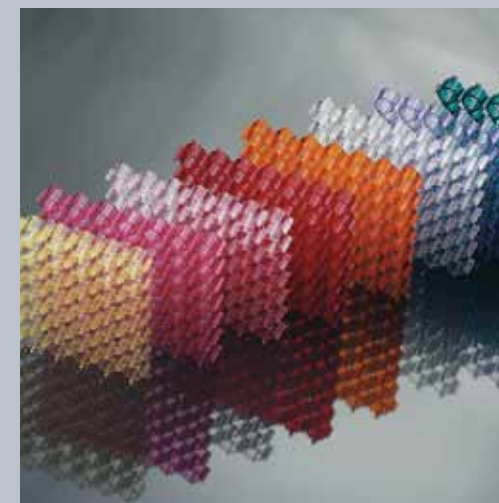

## Colors and finishes

- Finiture metallizzate e speciali: le finiture metallizzate argento, ottone, rame, nonché nel nuovo elegante effetto silver satinato, rendono preziosi i controsoffitti e donano effetti di luce straordinari (argento metallizzato e silver satinato sono di serie, le altre finiture speciali a richiesta per art.129, 140, 159, 169, 170, 190, e 202. Non disponibili per gli altri modelli).
- Metallic finishes: our metallic finishes allow for delightful, elegant and luxurious effects in gold, silver, copper and in the new silver satin (metallized silver and silver satin are standard finishes, other finishes on request for 129, 140, 159, 169, 170, 190 and 202 only).

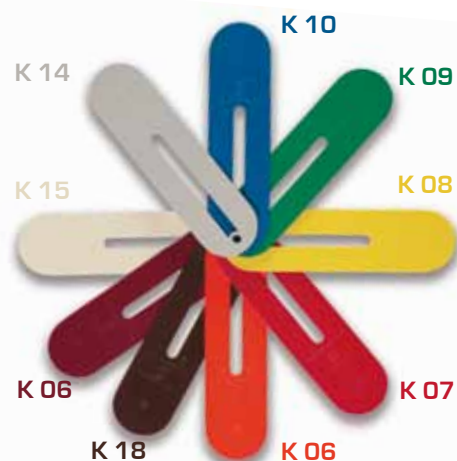
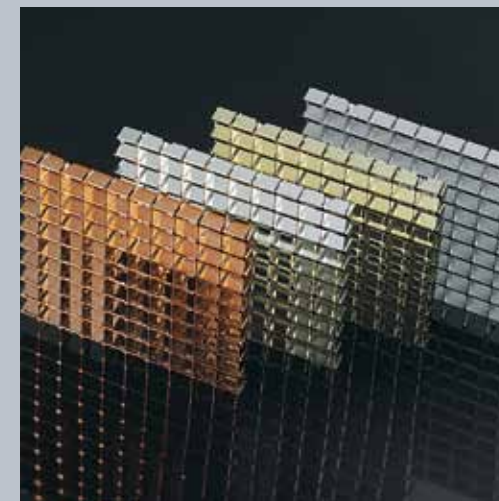



# 1



- Applicare un perimetrale di finitura alle pareti (legno, alluminio, plastica ecc.). Prevedere una pendinatura a soffitto, con interasse consigliato di ca. cm. 80.
- Apply an angular profile to the wall (wood, aluminium, plastic etc.). Apply the metal hooks to the ceiling at a recommended spacing of 80 cm. between each.

# 2



- Unire alcune griglie, rispettando il verso dei pannelli. Il primo pannello dovrà avere le alette rivolte verso le pareti, la facciata con i fori va verso l'alto per permettere la corretta sospensione.
- Join together a few panels, using a flat work surface for support, and insert hooks into the holes on the rear of the panels, to allow for suspension. Keep the panels facedown and facing in the same direction with the 'wing' side facing the wall.

## Montaggio Installation

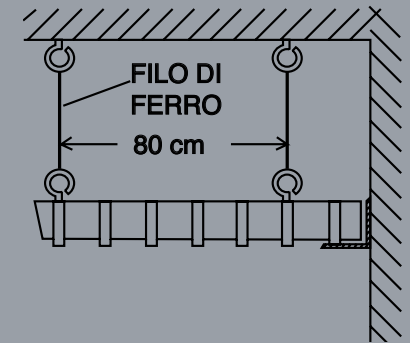

# 3



- Applicare un occhio da falegname in un foro sul retro di un pannello in corrispondenza del pendino a soffitto e sospendere il pannello mediante filo di ferro dolce (non usare filo di nylon). Rifilature o fori sui pannelli per ospitare spot, colonne ecc. si ottengono facilmente con una forbice da lattoniere o un qualsiasi seghetto.
- Begin assembly from the left hand corner of the room, suspending the panels from the hooks in the ceiling using metal wire. If necessary the panels may be cut to fit around obstacles (columns etc.) using a small hand-saw or strong scissors.

# 4



- Procedere con ulteriori pannelli eventualmente premontati a terra. La planarità del soffitto si ottiene operando sulla lunghezza del pendino. Per mantenere un livello costante dal pavimento è sufficiente un'asse di legno della lunghezza desiderata.
- Adjust the length of the suspension wires to ensure a level surface area, help yourselves with a wooden plank as a support for the panels.

# 5



- Il controsoffitto è facilmente ispezionabile: sganciando più pannelli lungo il lato di connessione si ottiene una "finestra" richiudibile.
- The upper part of the ceiling may be inspected, lighting fixtures above accessed etc. easily by lifting a 'window' of 3-4 panels along a connection point.

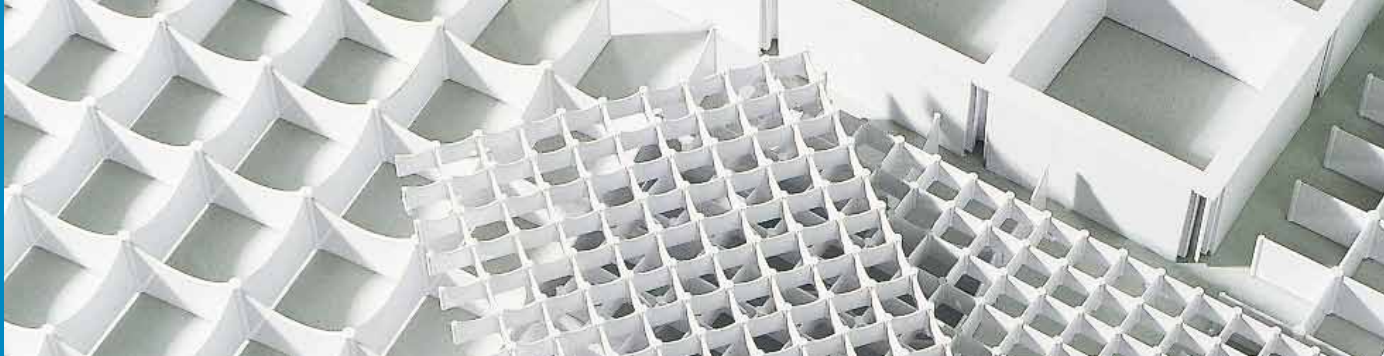

## CERTIFICAZIONI CERTIFICATES

### CERTIFICAZIONI

I controsoffitti PPP hanno ricevuto nel tempo numerosi riconoscimenti e certificazioni a livello internazionale. Rientrano nelle norme di omologazione in Polonia e a Cuba. Altri certificati sono in fase di rilascio. In un mondo sempre più attento alle problematiche ambientali, per la produzione dei grigliati si applicano inoltre da sempre tutte le tecnologie per un ridurre al minimo l'impatto con l'ambiente. L'ABS utilizzato è inoltre un materiale estremamente versatile e riciclabile.



### AUTOESTINGUENZA



P.P.P. garantisce che tutti i propri controsoffitti hanno superato con successo i severi test della normativa europea UNI EN 13964 conquistando il certificato di conformità CE. P.P.P. grazie ad un materiale d'avanguardia va oltre le caratteristiche dell'ABS autoestinguente e conquista l'EUROCLASSE B (in assoluto la migliore per i materiali plastici!). I nostri controsoffitti sigla FR hanno la più alta reazione e resistenza al fuoco: zero contributo alla propagazione e gocciolamento, bassissima emissione fumi... esaltando allo stesso tempo valori di resistenza meccanica, durata lucentezza ed estetica.

### CERTIFICATES

P.P.P. suspended ceilings have obtained many certificates and awards at international levels over the years, for their aesthetic, practical and functional characteristics. Certification is in progress in a number of countries world-wide at present (Poland, Cuba...). In a world continually more aware of environmental problems, the production of our ceiling panels follows all technological procedures adapted to minimising impact on the environment. The ABS thermoplastic used is extremely versatile and recyclable.



### FIRE RESISTANCE

P.P.P. guarantees that all of its Open Cell Suspended Ceilings have passed rigorous tests required by UNI EN 13964 European Regulation and gained the CE Certificate of Conformity. P.P.P. thanks to an advanced material, has overcome the characteristics of self-extinguishing ABS and gained Euroclass B (absolutely the best rank for a plastic material at present!). These Open Cell Suspended Ceilings, labelled FR have the highest degree of fire resistance: no contribution to the spreading of fire, no drip, a very low emission of smoke... at the same time these items are distinguished by excellent mechanical resistance, lastingness brilliance and design.

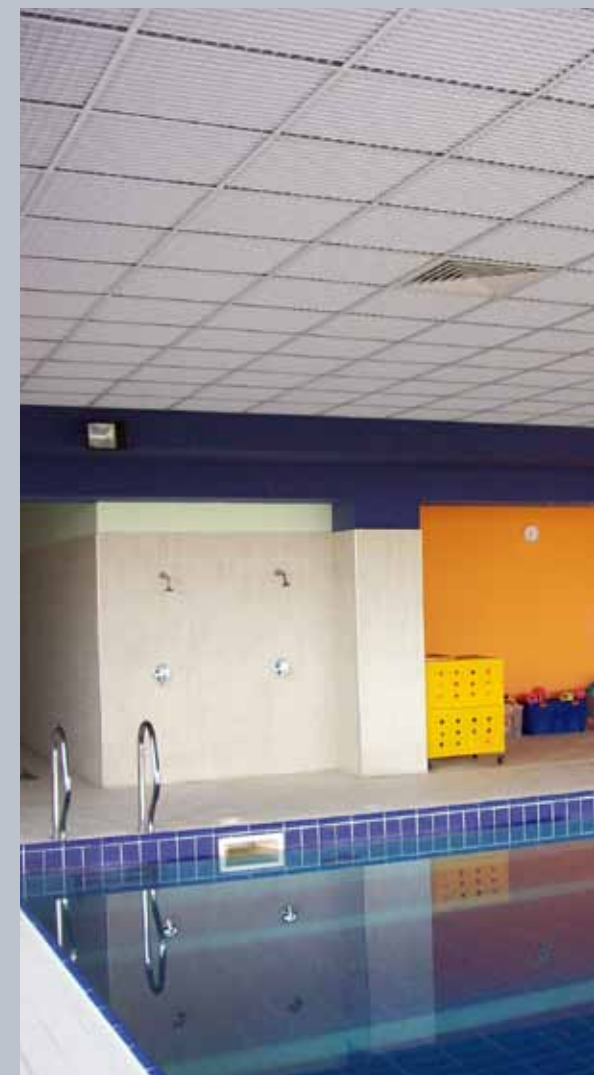



## AVVERTENZE E CONSIGLI UTILI NOTES AND SUGGESTIONS

- Tutti i grigliati sono stampati con ottime caratteristiche antistatiche. Si consiglia comunque di non installare il prodotto in ambienti polverosi e/o di applicarli nell'ultima fase del cantiere. Aprire i cartoni immediatamente prima del loro impiego.
  - In caso di grandi superfici si consiglia prevedere lungo il perimetro uno spazio di dilatazione termica. La variazione media è di 1 mm. al metro lineare ogni 10°C di escursione.
  - Per il miglior risultato nel montaggio dei grigliati metallizzati si consiglia l'utilizzo di guanti leggeri di cotone al fine di evitare impronte.
  - Un lieve infragilimento del prodotto dopo 5-8 anni (dipendentemente dalle condizioni di applicazione) è da considerarsi normale e non pregiudica le caratteristiche estetiche e funzionali del prodotto.
  - Il "color range" della materia prima è mantenuto dalle case produttrici entro parametri strettissimi per assicurare la massima uniformità di colore nel tempo. Tuttavia, per esigenze di produzione indipendenti dalla nostra volontà possono riscontrarsi lievissime variazioni di tonalità tra lotti diversi.
  - PPP non risponde per problemi che dovessero emergere da uso improprio dei grigliati o da un montaggio diverso da quello consigliato.
  - Le caratteristiche dei grigliati possono subire variazioni senza preavviso unicamente allo scopo di migliorare il prodotto.
- The panels are injection moulded in anti-static ABS. It is recommended, however, that during the installation process the panels are kept boxed and away from sources of dust until ready to be used.
  - In the case of the installation of large surface areas, it is recommended that a small distance is maintained between the outer panels and the wall. This will allow for expansion and contraction of the ceiling panels corresponding with temperature changes. The average expansion measurement is 1mm per linear metre for every 10°C variation in temperature.
  - It is recommended that metallic finish ceilings be handled using soft gloves to avoid marking.
  - After a period of 5-8 years an increased fragility may be noticed in the panels. This is normal for the material and will not effect the look or functionality of the ceiling.
  - The colour range of the materials provided by our suppliers is tightly controlled to ensure maximum uniformity, however, very slight variations in colour may occur.
  - P.P.P. is not liable for any damages to the product resulting from improper use or installation undertaken in a manner differently from that recommended by P.P.P.
  - The characteristics of the ceiling panels may be subject to change without notice, with the purpose of ensuring improvements in quality.



P.P.P. PRODOTTI POLIPLASTICI S.r.l.

Via Torino, 184 30172 Mestre (VE) - Italia Tel. +39 041 5310150 r.a. fax +39 041 5312826  
internet: [www.ppp.it](http://www.ppp.it) e-mail: [info@ppp.it](mailto:info@ppp.it)

