

# Ventilazione e aerazione silenziosa

Catalogo | Catalog  
**2022**



VENT



IT

**Ventilazione e aerazione silenziata.**

La gamma completa per l'isolamento acustico di facciata dei fori di aereazione e ventilazione, dei condotti di aerazione delle cappe aspiranti delle cucine e dei condotti di aspirazione dei bagni, concepiti per raggiungere valori di isolamento acustico conformi ai requisiti acustici passivi degli edifici.

.....

EN

***Silenced aeration and ventilation.***

*Complete range for the acoustic insulation of the facade of the aeration and ventilation holes; of ventilation ducts of the range hoods of kitchens and of the intake ducts of bathrooms, designed to achieve sound insulation values that comply with the passive acoustic requirements of buildings.*



<b>LINEA VENT VENT LINE</b>	04
Introduzione <i>Introduction</i>	
<b>VENTILAZIONE NATURALE SILENZIATA</b> <b>NATURAL SILENCED VENTILATION</b>	08
Edifici di nuova costruzione <i>New buildings</i>	
Edifici abitati <i>Inhabited buildings</i>	
<b>AMBIENTE CIVILE</b> <b>CIVIL ENVIRONMENTS</b>	20
<b>AMBIENTE INDUSTRIALE</b> <b>INDUSTRIAL ENVIRONMENTS</b>	24
<b>GLI SCATOLATI</b> <b>THE CASES</b>	26
Kit Rumor Block <b>Normal / Structure</b> <i>Kit rumor block Normal / Structure</i>	
<b>I TUBOLARI</b> <b>THE TUBULAR</b>	34
Kit tubo piuma 160 <i>Kit tubo piuma 160</i>	
Kit tubo antivento 160 <i>Kit tubo antivento 160</i>	
Tubo piuma <i>Tubo piuma</i>	
Quadro piuma <i>Quadro piuma</i>	
Kit tubo marmitta <i>Kit tubo marmitta</i>	
<b>ACCESSORI</b> <b>ACCESSORIES</b>	58
Aggancio flex <i>Hooking flex</i>	
Griglie <i>Gratings</i>	
Esalatore antivento <i>Windproof vent</i>	
Airplak <i>Airplak</i>	





# LINEA VENT

---

VENT LINE

# INTRODUZIONE



## INTRODUCTION

IT

### GLI SPECIALISTI DELLA AERAZIONE E VENTILAZIONE SILENZIATA

#### **Soluzioni innovative per l'aerazione silenziosa e la ventilazione naturale silenziosa.**

Eterno Ivica produce e commercializza soluzioni innovative per l'aerazione e la ventilazione silenziosa degli ambienti abitativi.

RUMOR BLOCK è una gamma completa di silenziatori per l'isolamento acustico di facciata dei fori di aerazione e ventilazione, dei condotti di aerazione delle cappe aspiranti delle cucine e dei condotti di aspirazione dei bagni, concepiti per raggiungere valori di isolamento acustico conformi ai requisiti acustici passivi degli edifici (D.P.C.M. del 05/12/97).

I dispositivi RUMOR BLOCK possono essere dotati di diffusori interni AIRPLAK per la ventilazione naturale silenziosa degli ambienti, caratterizzati da tecnologia avanzata e design elegante.

EN

### SPECIALISTS IN SILENCED AERATION AND VENTILATION

#### **Innovative solutions for silenced aeration and natural silenced ventilation.**

Eterno Ivica manufactures and markets innovative solutions for the silenced aeration and ventilation of living environments.

RUMOR BLOCK is a complete range of silencers for the acoustic insulation of the facade of the aeration and ventilation holes, of ventilation ducts of the range hoods of kitchens and of the intake ducts of bathrooms, designed to achieve sound insulation values that comply with the passive acoustic requirements of buildings (D.P.C.M. of 05/12/97).

The RUMOR BLOCK devices can be equipped with AIRPLAK internal diffusers for natural silenced ventilation of the environments, characterized by advanced technology and elegant design.





# VENTILAZIONE NATURALE SILENZIATA

---

## NATURAL SILENCED VENTILATION

IT

Ventilazione naturale silenziosa per evitare  
la formazione di muffe da condensa.

EN

*Natural silenced ventilation to prevent the  
formation of mold by moisture.*



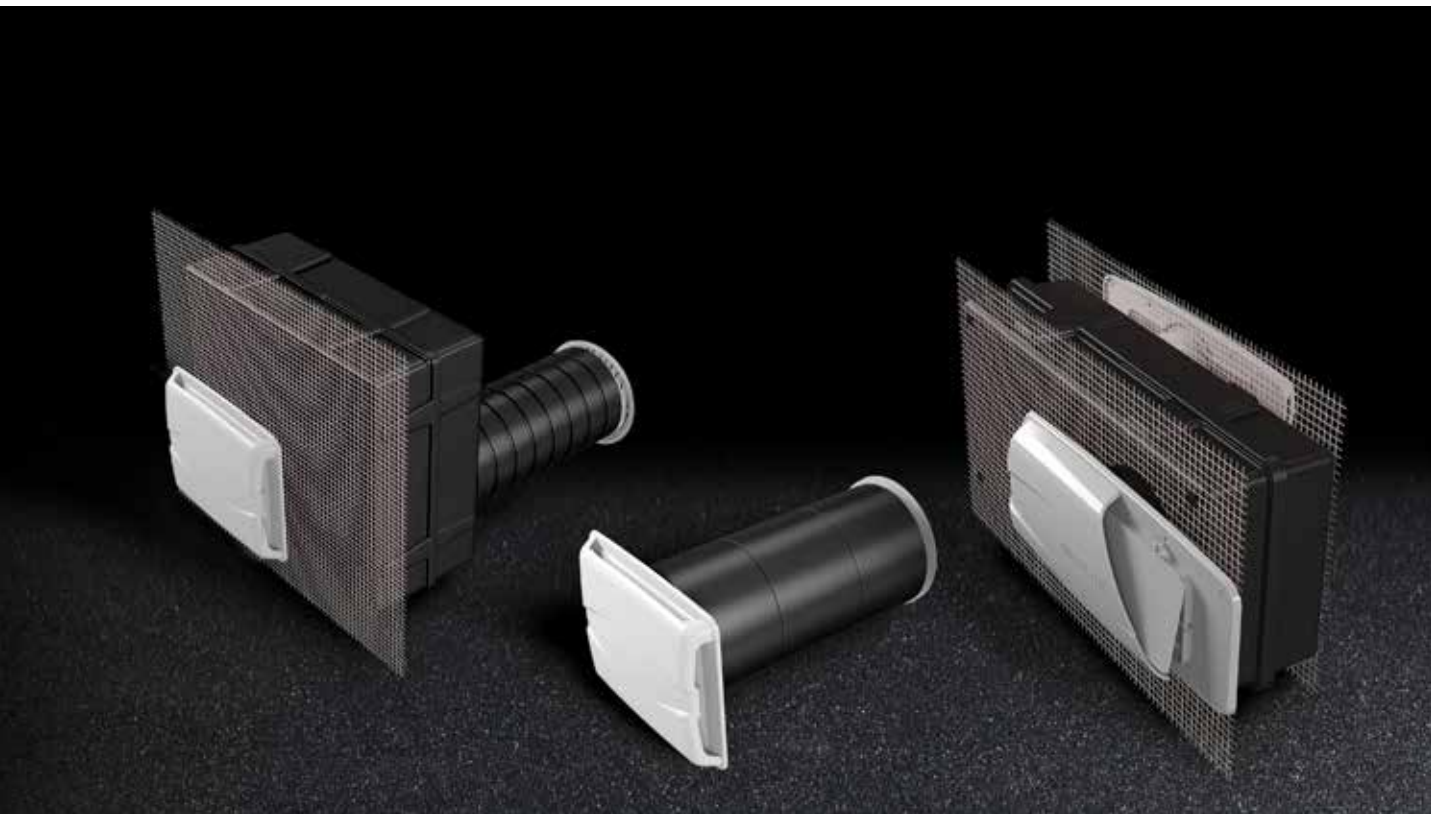

EDIFICI DI NUOVA COSTRUZIONE  
*NEW BUILDINGS*

EDIFICI ABITATI  
*INHABITATED BUILDINGS*

# VENTILAZIONE NATURALE SILENZIATA

## NATURAL SILENCED VENTILATION

IT

Per rispondere in maniera sempre più puntuale ed efficace alle esigenze di risparmio energetico degli edifici, i moderni serramenti sono progettati per offrire una tenuta ermetica che rende le abitazioni dei contenitori stagni. È pertanto fondamentale garantire un ricambio d'aria in ogni ambiente dell'abitazione per la vivibilità delle persone e per prevenire la formazione di pericolose condense superficiali sulle pareti, terreno fertile per la proliferazione di muffe.

AIRPLAK è un sistema di ricambio d'aria naturale, silenziato e continuo, basato sul principio del moto convettivo dell'aria (detto anche "Effetto camino").

Attraverso uno o più fori di ventilazione praticati nelle pareti perimetrali in prossimità del pavimento, affluisce all'interno degli edifici l'aria esterna di rinnovo creando una pressione che spinge verso l'alto quella interna, più calda e leggera, umida e viziata, che viene convogliata ed espulsa all'esterno attraverso i fori di aerazione silenziati realizzati in prossimità del soffitto.

EN

*In order to respond more promptly and effectively to the requirements of energy saving in buildings, modern windows are designed to provide an airtight seal that make the dwellings of waterproof containers. It is therefore essential to ensure air exchange in every dwelling environment for the living conditions of people and to prevent the formation of dangerous surface condensation on the walls, a breeding ground for mold growth.*

*AIRPLAK is a natural air replacement system, silenced and continuous, based on the principle of the convective motion of air (also called "chimney effect").*

*through one or more ventilation holes in the perimeter walls near the floor, outside air renewal flows into the interior of the buildings by creating a pressure that pushes the inner air upward, warmer and lighter, moist and stale, which is conveyed and ejected to the outside through the silenced aeration holes made in the vicinity of the ceiling.*



> VIDEO GUIDA VENTILAZIONE NATURALE SILENZIATA  
> VIDEO GUIDE NATURAL SILENCED VENTILATION



**A** Kit Rumor Block Normal RBN da 100 cm<sup>2</sup>,  
consigliato per l'entrata d'aria della cucina.  
*Kit Rumor Block Normal RBN of 100 cm<sup>2</sup>,  
recommended for the entry of air in the kitchen.*

**B** Kit Rumor Block Normal RBN da 100 cm<sup>2</sup>,  
consigliato per l'espulsione d'aria della cappa aspirante della cucina.  
*Kit Rumor Block Normal RBN of 100 cm<sup>2</sup>,  
recommended for the expulsion of air from the range hood in the kitchen.*

**C** Kit Rumor Block Minor T8 da 40 cm<sup>2</sup>,  
consigliato per l'espulsione d'aria "viziata".  
*Kit Rumor Block Minor T8 from 40 cm<sup>2</sup>,  
recommended for the expulsion of "stale" air.*

**D** Kit Rumor Block Minor T8 da 40 cm<sup>2</sup>,  
consigliato per il transito d'aria tra ambienti.  
*Kit Rumor Block Minor T8 from 40 cm<sup>2</sup>,  
recommended for the air transit between environments.*

**E** Kit Rumor Block Minor T8 da 40 cm<sup>2</sup>,  
Airplak 40V, consigliato per il transito d'aria nel bagno.  
*Kit Rumor Block Minor T8 from 40 cm<sup>2</sup>,  
with Airplak 40V, recommended for the air transit in the bathroom.*



# EDIFICI DI NUOVA COSTRUZIONE

## NEW BUILDINGS

IT

**PRODOTTI PER LA VENTILAZIONE  
NATURALE SILENZIATA PER EDIFICI DI  
NUOVA COSTRUZIONE.**

EN

**PRODUCTS FOR NATURAL SILENCED  
VENTILATION FOR THE CONSTRUCTION  
OF NEW BUILDINGS.**

A

Kit Rumor Block Normal RBN da 100 cm<sup>2</sup>  
(UNI-CIG 7129/15), consigliato per l'entrata d'aria della cucina.  
*Kit Rumor Block Normal RBN of 100 cm<sup>2</sup>  
(UNI-CIG 7129/15), recommended for the entry of air in the kitchen.*



CODICE CODE	TIPO TYPE	ABBATTIMENTO ACUSTICO NOISE REDUCTION	MISURA SIZE	PASS. ARIA AIR PASSAGE	PAG LISTINO PRICE LIST PAGE	PZ 
P200001535	KIT RBN 15/35	D <sub>n,e,w</sub> = <b>53,9 dB</b> (certified)	290x350x150 mm	cm <sup>2</sup> 100	6	1
P200001229	KIT RBN 12/29	D <sub>n,e,w</sub> = <b>50 dB</b> (certified)	290x350x120 mm	cm <sup>2</sup> 100	6	1

B

Kit Rumor Block Normal RBN da 100 cm<sup>2</sup> (UNI-CIG 7129/15),  
consigliato per l'espulsione d'aria della cappa aspirante della cucina.  
*Kit Rumor Block Normal RBN of 100 cm<sup>2</sup> (UNI-CIG 7129/15),  
recommended for the expulsion of air from the range hood in the kitchen.*



CODICE CODE	TIPO TYPE	ABBATTIMENTO ACUSTICO NOISE REDUCTION	MISURA SIZE	PASS. ARIA AIR PASSAGE	PAG LISTINO PRICE LIST PAGE	PZ 
P200001515	KIT RBN 15/15	D <sub>n,e,w</sub> = <b>49,6 dB</b> (certified)	370x150x150 mm	cm <sup>2</sup> 100	6	1
P200001220	KIT RBN 12/20	D <sub>n,e,w</sub> = <b>49,3 dB</b> (certified)	370x200x120 mm	cm <sup>2</sup> 100	6	1

I kit (A) e (B) sono composti da 4 elementi:

Kit (A) and (B) consists of 4 elements:

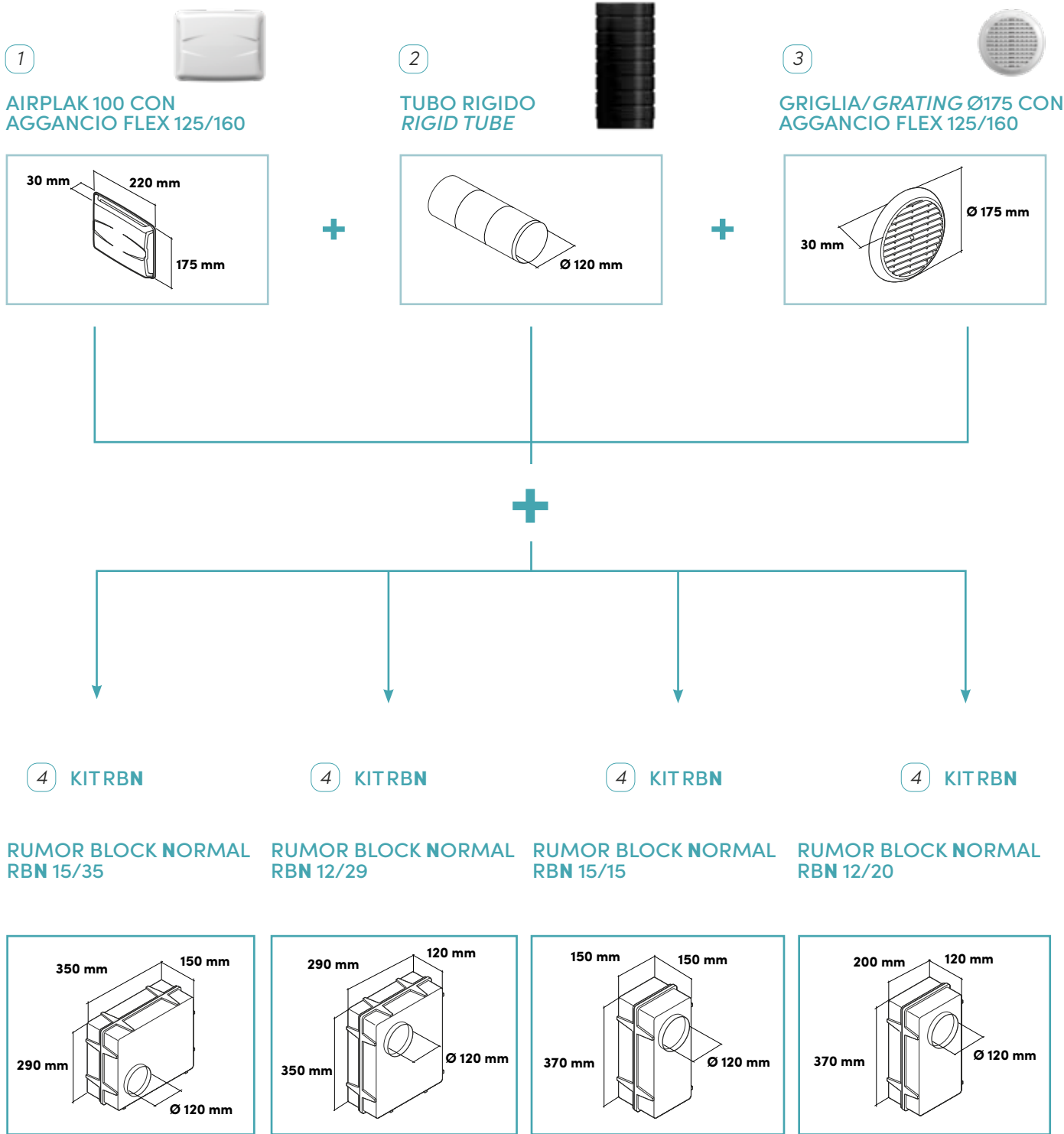

**IL KIT C È COMPOSTO DA 4 ELEMENTI:**

**KIT C CONSISTS OF 4 ELEMENTS:**

1 

**AIRPLAK 40 CON  
AGGANCIO FLEX 80/100**

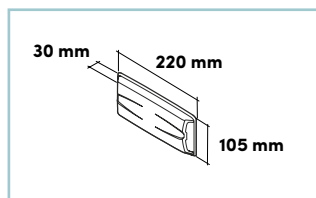

NB.: Da posizionarsi all'interno  
NOTE: To be placed on the inside

2 

**RUMOR BLOCK  
MINOR T8**

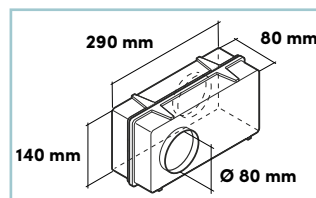

3 

**TUBO RIGIDO  
RIGID TUBE**

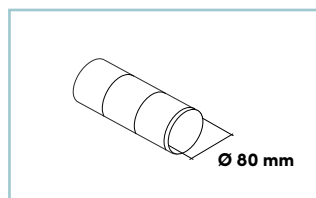

4 

**ESALATORE/ROOF VENT Ø115  
CON AGGANCIO FLEX 80/100**

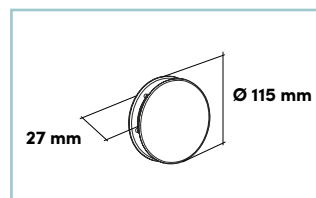

NB.: Da posizionarsi all'esterno  
NOTE: To be placed on the outside



Kit Rumor Block Minor T8 da 40 cm<sup>2</sup>,  
consigliato per l'espulsione d'aria "viziata".

*Kit Rumor Block Minor T8 from 40 cm<sup>2</sup>,  
recommended for the expulsion of "stale" air.*

<b>CODICE</b> CODE	<b>TIPO</b> TYPE	<b>ABBATTIMENTO ACUSTICO</b> NOISE REDUCTION	<b>MISURA</b> SIZE	<b>PASS. ARIA</b> AIR PASSAGE	<b>PAG LISTINO</b> PRICE LIST PAGE	<b>PZ</b> 
P200211208	Kit minor uscita/Exit	D <sub>n,e,w</sub> = 51 dB	290x140x80 mm	cm <sup>2</sup> 40	7	1



**IL KIT (D) È COMPOSTO DA 3 ELEMENTI:**

**KIT (D) CONSISTS OF 3 ELEMENTS:**

1



**AIRPLAK 40 CON  
AGGANCIO FLEX 80/100**

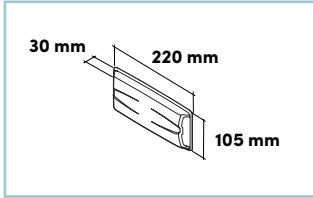

2



**RUMOR BLOCK  
MINOR T8**

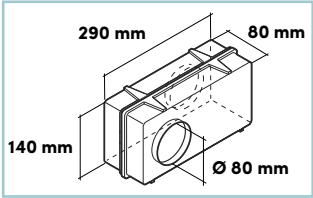

3



**AIRPLAK 40 CON  
AGGANCIO FLEX 80/100**

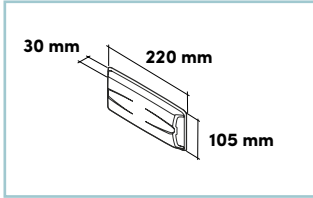



Kit Rumor Block Minor T8 da 40 cm<sup>2</sup>,  
consigliato per il transito d'aria tra ambienti. *Kit Rumor Block Minor T8 from 40 cm<sup>2</sup>,  
recommended for the air transit between environments.*

CODICE CODE	TIPO TYPE	ABBATTIMENTO ACUSTICO NOISE REDUCTION	MISURA SIZE	PASS. ARIA AIR PASSAGE	PAG LISTINO PRICE LIST PAGE	PZ 
P200221208	Kit minor transito/Exit	D <sub>n,e,w</sub> = 51 dB	290x140x80 mm	cm <sup>2</sup> 40	7	1

**IL KIT (E) È COMPOSTO DA 3 ELEMENTI:**

**KIT (E) CONSISTS OF 3 ELEMENTS:**

1



**AIRPLAK 40V CON  
VALVOLA ANTIRITORNO  
E AGGANCIO FLEX 80/100**

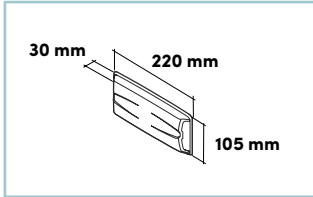

2



**RUMOR BLOCK  
MINOR T8**

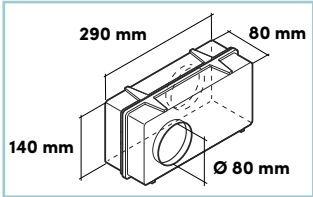

3



**AIRPLAK 40 CON  
AGGANCIO FLEX 80/100**

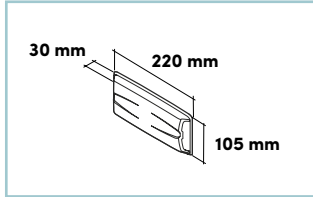



NB: Airplak 40V da posizionare nella parte interna del bagno  
*NOTE: Airplak 40V to be positioned in the inner part of the bathroom*

Kit Rumor Block Minor T8 da 40 cm<sup>2</sup>,  
Airplak 40V (valvola anti-ritorno),  
consigliato per il transito d'aria nel bagno. *Kit Rumor Block Minor T8 from 40 cm<sup>2</sup>  
with Airplak 40V (anti-return valve),  
recommended or the air transit in the bathroom.*

CODICE CODE	TIPO TYPE	ABBATTIMENTO ACUSTICO NOISE REDUCTION	MISURA SIZE	PASS. ARIA AIR PASSAGE	PAG LISTINO PRICE LIST PAGE	PZ 
P200321208	Kit minor transito per bagno <i>Transit for bathroom</i>	D <sub>n,e,w</sub> = 51 dB	290x140x80 mm	cm <sup>2</sup> 40	7	1

# EDIFICI ABITATI

## INHABITED BUILDINGS

IT

**PRODOTTI PER LA VENTILAZIONE  
NATURALE SILENZIATA PER EDIFICI  
ABITATI.**

EN

**PRODUCTS FOR THE NATURAL  
SILENCED VENTILATION OF INHABITED  
BUILDINGS.**

A

Kit Tubo Piuma 160 da 100 cm<sup>2</sup>  
consigliato per l'entrata d'aria della cucina.  
*Kit Tubo Piuma 160 from 100 cm<sup>2</sup>  
recommended for the entry of air in the kitchen.*



**AIRPLAK 100  
CON IMBOCCO Ø160**



**TUBO PIUMA Ø160**



**TUBO RIGIDO  
RIGID TUBE**



**GRIGLIA/GRATING Ø175  
CON IMBOCCO/INLET Ø160**

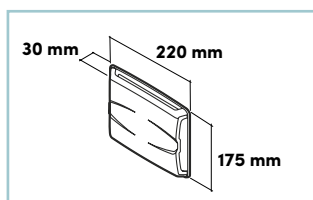

NB.: Da posizionarsi all'interno  
*NOTE: To be placed on the inside*

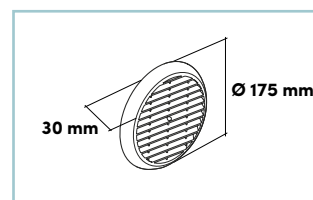
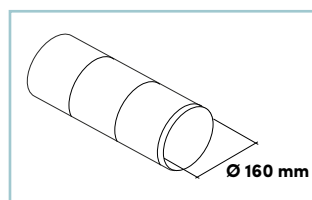
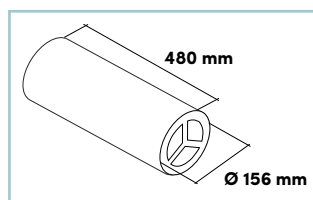

NB.: Da posizionarsi all'esterno  
*NOTE: To be placed on the outside*

CODICE CODE	TIPO TYPE	ABBATTIMENTO ACUSTICO NOISE REDUCTION	DIAMETRO DIAMETER	LUNGHEZZA STANDARD STANDARD LENGHT	PASS. ARIA AIR PASSAGE	PAG LISTINO PRICE LIST PAGE	PZ 
P203000160	KIT ENTRATA ARIA <i>KIT AIR ENTRY</i> TUBO PIUMA 160	Dn,e,w = 48 dB (certified)	Ø 160 mm	480 mm	cm <sup>2</sup> 100	8	1

**B**

**Kit Tubo Piuma 160 da 100 cm<sup>2</sup>**  
 consigliato per l'espulsione d'aria della cappa aspirante della cucina.  
*Kit Tubo Piuma 160 from 100 cm<sup>2</sup>*  
*recommended for the expulsion of air from the range hood of the kitchen.*



**ESALATORE/ROOF VENT Ø 175**  
**CON AGGANCIAMENTO FLEX 160/120**

**TUBO PIUMA Ø160**

**TUBO RIGIDO**  
**RIGID TUBE**

**AIRPLAK 100**  
**CON IMBOCCO/**  
**INLET Ø 160**

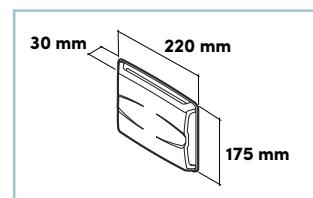
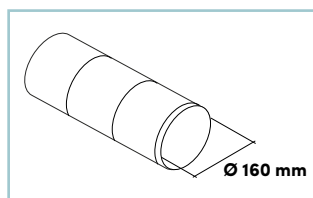
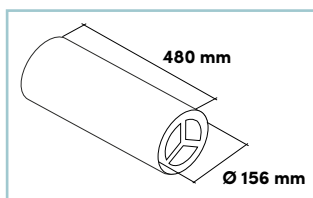
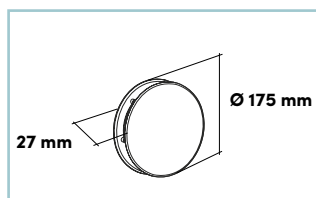

NB.: Da posizionarsi all'esterno  
 NOTE: To be placed on the outside

NB.: Da posizionarsi all'interno  
 NOTE: To be placed on the inside

CODICE CODE	TIPO TYPE	ABBATTIMENTO ACUSTICO NOISE REDUCTION	DIAMETRO DIAMETER	LUNGHEZZA STANDARD STANDARD LENGHT	PASS. ARIA AIR PASSAGE	PAG LISTINO PRICE LIST PAGE	PZ 
P209000160	KIT ESPULSIONE ARIA KIT AIR EXPULSION TUBO PIUMA 160	D <sub>n,e,w</sub> = 48 dB (certified)	Ø 160 mm	480 mm	cm <sup>2</sup> 100	8	1

**C**

**Kit Tubo Piuma 80 da 19,6 cm<sup>2</sup>**  
 consigliato per l'espulsione d'aria "viziata".  
*Kit Tubo Piuma 80 from 19,6 cm<sup>2</sup>*  
*recommended for the expulsion of "stale" air.*

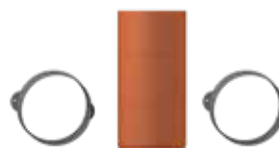

**AIRPLAK 40 CON**  
**AGGANCIAMENTO FLEX 80/100**

**TUBO PIUMA Ø80**

**TUBO RIGIDO/**  
**RIGID TUBE Ø 82 +**  
**FERMATUBO/TUNE CLIP**

**ESALATORE/ROOF VENT**  
**Ø115 CON AGGANCIAMENTO**  
**FLEX Ø 80/100**

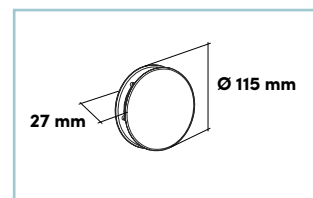
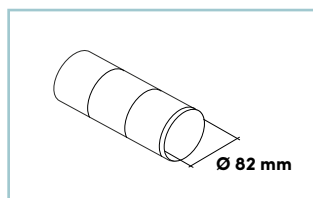
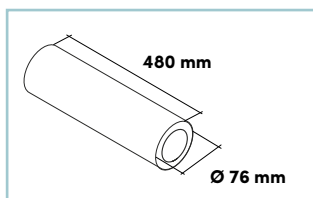
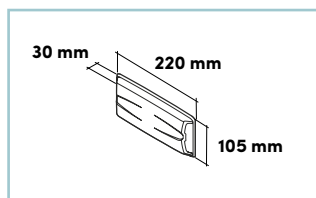

NB.: Da posizionarsi all'interno  
 NOTE: To be placed on the inside

NB.: Da posizionarsi all'esterno  
 NOTE: To be placed on the outside

CODICE CODE	TIPO TYPE	ABBATTIMENTO ACUSTICO NOISE REDUCTION	DIAMETRO DIAMETER	LUNGHEZZA STANDARD STANDARD LENGHT	PASS. ARIA AIR PASSAGE	PAG LISTINO PRICE LIST PAGE	PZ 
P202000080	KIT ESPULSIONE ARIA KIT AIR EXPULSION TUBO PIUMA 80	D <sub>n,e,w</sub> = 49 dB (certified)	Ø 80 mm	480 mm	cm <sup>2</sup> 19,6	9	1

# PERCHÉ USARE I PRODOTTI RUMOR BLOCK?

## WHY USE THE RUMOR BLOCK PRODUCTS?

IT

### **Per rispondere alle esigenze di isolamento acustico dei fori di aerazione e ventilazione.**

Le norme UNI CIG 7129/2015 in materia di sicurezza prevedono che negli ambienti destinati a uso cucina con apparecchi a gas a fiamma libera, forni o fornelli, siano praticate aperture di aerazione e ventilazione sulle facciate per far affluire l'aria necessaria alla combustione.

I fori di aerazione e ventilazione, oltre al passaggio dell'aria, favoriscono anche la trasmissione dei rumori aerei esterni verso l'interno degli edifici: per questo è necessario applicare ad essi dispositivi fonoassorbenti in grado di soddisfare i requisiti acustici passivi degli edifici come previsti dalla legge 447/95 e dal D.P.C.M. del 5/12/97.

I Silenziatori acustici RUMOR BLOCK sono la soluzione ideale per l'aerazione e ventilazione silenziata di ambienti domestici garantendo le migliori prestazioni di isolamento acustico della categoria.

I silenziatori RUMOR BLOCK, coperti da brevetto, consentono un passaggio d'aria di 100 cm<sup>2</sup> conformemente a quanto previsto dalle norme UNI CIG 7129/2015 e, in virtù delle loro elevate proprietà fonoassorbenti e dissipative certificate, raggiungono valori di isolamento acustico eccellenti fino a  $D_{n,e,w} = 57$  dB, secondo la norma UNI EN ISO 717-1 e ISO 140-10.

EN

### **To meet the needs of sound insulation of the aeration and ventilation holes.**

*The UNI CIG 7129/2015 standards regarding safety predict that in environments intended for kitchen use with open flame gas appliances, ovens or cookers, aeration and ventilation openings on the facades are put into place in order to help the air flow required for combustion.*

*The aeration and ventilation holes, in addition to the air passage, also favour the transmission of external airborne noise towards the interior of the buildings: for this reason it is necessary to apply to them sound-absorbing devices that are able to meet the passive acoustic requirements of buildings as expected by law 447/95 and DPCM of 5/12/97.*

*The RUMOR BLOCK acoustic silencers are ideal for the silenced aeration and ventilation of the home environment ensuring the best sound insulation performance in its class.*

*The RUMOR BLOCK silencers, covered by a patent, allow an air passage of 100 cm<sup>2</sup> in accordance with the requirements of UNI CIG 7129/2015 and, by virtue of their high sound-absorbing properties and certified dissipation, achieve excellent sound insulation values up to  $D_{n,e,w} = 57$  dB, according to the UNI EN ISO 717-1 and ISO 140-10 standards.*

## PROBLEMI COMUNI DOVUTI AI FORI DI VENTILAZIONE COMMON PROBLEMS DUE TO VENTILATION HOLES



- 1 Rumore proveniente dai fori di ventilazione delle pareti esterne  
*Noise coming from the ventilation holes of outside walls*
- 2 Problemi di muffa in assenza di adeguata ventilazione  
*Mold problems in the absence of adequate ventilation*
- 3 Fastidiosi flussi d'aria diretti  
*Annoying direct air flows*

IT

### La soluzione con i prodotti rumor block della linea vent.

I silenziatori acustici RUMOR BLOCK sono concepiti per essere impiegati sia in ambito civile che industriale, per isolare acusticamente condotti di aerazione e ventilazione singoli o collettivi, contrastando quindi sia i rumori provenienti dall'esterno che quelli eventualmente provenienti da aspiratori centralizzati. I dispositivi RUMOR BLOCK sono dotati, sul lato interno del nuovo diffusore d'aria perimetrale AIRPLAK, in grado di garantire il ricambio d'aria previsto dalle normative e consentire lo smaltimento dell'umidità che si forma all'interno degli ambienti, prevenendo così la formazione di condense o muffe. Il funzionamento del sistema si basa sul principio del moto convettivo dell'aria o effetto camino e assicura, grazie alla microventilazione, un tasso di ricambio d'aria completo di 0,2/h.

EN

### The solution with the products from the rumor block vent line.

The RUMOR BLOCK acoustic silencers are designed to be used both in civil and industrial sectors, in order to acoustically insulate single or collective aeration and ventilation ducts, counteracting then both the noise coming from outside as well as those possibly coming from centralized exhaust fans. The RUMOR BLOCK devices are equipped, on the inner side of the new AIRPLAK perimeter air diffuser, able to ensure the exchange of air required by regulation and to allow the elimination of the humidity that forms inside of these environments, thus preventing the formation of condensation or mold. The operation of the system is based on the principle of the convective motion of the air, or chimney effect, and ensures, thanks to micro ventilation, a complete air exchange rate of 0,2 / h.

# AMBIENTE CIVILE

## CIVIL ENVIRONMENTS

IT

**I prodotti della linea vent possono essere utilizzati in ambiente civile.**

In ambito civile, i silenziatori acustici da incasso **RUMOR BLOCK** trovano applicazione in molteplici contesti: per l'aerazione e ventilazione silenziosa degli ambienti domestici, per l'isolamento acustico di condotti di aerazione delle cappe aspiranti con l'uscita a parete, per condotti di aspirazione dei bagni e di condizionamento, singoli o collettivi, nuovi o già esistenti.

I silenziatori acustici di facciata **RUMOR BLOCK** per l'aerazione e ventilazione di ambienti domestici permettono di realizzare il migliore abbattimento acustico della loro categoria.

I silenziatori acustici della gamma **RUMOR BLOCK** nascono per soddisfare qualsiasi esigenza dimensionale, pratica e acustica. I silenziatori **RUMOR BLOCK** consentono un passaggio d'aria di 100 cm<sup>2</sup> secondo le norme UNI CIG 7129/2015 e sono coperti da brevetto.

I silenziatori **RUMOR BLOCK** sono disponibili in diverse tipologie, tutte ispezionabili, con una gamma che si sviluppa in dodici modelli scatolati e 2 modelli tubolari di diametro 160 mm.

EN

**The products of the vent line can be used in civil environments.**

*In the civil sector, **RUMOR BLOCK** recessed acoustic silencers are applicable in a variety of contexts: for the silenced aeration and ventilation of domestic environments, for acoustic insulation of the ventilation ducts of range hoods with a wall outlet, for aspiration ducts of bathrooms and air conditioning, either individual or collective, new or existing.*

*The **RUMOR BLOCK** facade acoustic silencers for the aeration and ventilation of domestic environments allow you to achieve the best sound reduction in their class.*

*The acoustic silencers of the **RUMOR BLOCK** range were made to satisfy all dimensional, practical and acoustics requirements. The **RUMOR BLOCK** silencers allow an air passage of 100 cm<sup>2</sup> according to UNI CIG 7129/2015 standards and are covered by the patent.*

*The **RUMOR BLOCK** silencers are available in different types, all inspected, with a range that develops in twelve boxed models and two tubular models with a diameter of 160 mm.*



**KIT RUMOR BLOCK N**  
**KIT RUMOR BLOCK S**



**KIT MINOR T8**



**KIT TUBO PIUMA 80**



# LA VENTILAZIONE IN CUCINA

## KITCHEN VENTILATION

IT

### **Aerazione e ventilazione silenziosa delle cucine: salubrità senza rumori**

I silenziatori acustici di facciata **RUMOR BLOCK** per fori di aerazione e ventilazione, sono dispositivi dalle dimensioni ridotte, disponibili in molteplici modelli per tutte le esigenze realizzative, che si incassano nella parete esterna consentendo il passaggio dell'aria previsto dalle norme non inferiore a 100 cm<sup>2</sup>, abbattendo contestualmente i rumori esterni che da tali fori si potrebbero trasmettere verso l'interno. I silenziatori acustici **RUMOR BLOCK** permettono quindi di realizzare una efficace aerazione e ventilazione nei vani cucina preservando un elevato grado di isolamento acustico dell'involucro.

Grazie alla loro versatilità i prodotti della gamma **RUMOR BLOCK**, nei vani cucina, trovano ideale applicazione anche per l'isolamento dei fori dei condotti di aerazione delle cappe aspiranti, facilmente installabili anche in edifici e condotti esistenti.

EN

### **Silenced aeration and ventilation of kitchens: healthiness without noise.**

*The **RUMOR BLOCK** facade acoustic silencers for aeration and ventilation holes, are devices with reduced size, available in multiple models for all production requirements, which can be embedded in the outer wall allowing the passage of air expected by regulations of not less than 100 cm<sup>2</sup>, simultaneously reducing the external noise that from such holes could be transmitted inward. The **RUMOR BLOCK** acoustic silencers therefore allow for the realization of effective aeration and ventilation in kitchen spaces preserving a high degree of sound insulation of the casing.*

*Thanks to their versatility, the products of the **RUMOR BLOCK** range, in the kitchen spaces, are also ideal for the isolation of the holes of ventilation ducts of the range hoods, which can be easily installed in existing buildings and ducts.*





# AMBIENTE INDUSTRIALE

## INDUSTRIAL ENVIRONMENTS

IT

In ambito industriale, i silenziatori acustici **RUMOR BLOCK** sono preziosi alleati per l'isolamento acustico di condotti di aerazione e ventilazione delle cappe aspiranti delle cucine di alberghi, bar, ristoranti, laboratori, oltre che dei condotti di ventilazione con immissione o estrazione di aria, condotti dell'aria condizionata, box silenziati, sia per impianti nuovi o già esistenti.

I silenziatori acustici di facciata **RUMOR BLOCK** per l'aerazione e ventilazione di ambienti industriali, raggiungono prestazioni elevate di abbattimento acustico per il migliore comfort negli ambienti di lavoro.

I silenziatori acustici della gamma **RUMOR BLOCK** inseriti nei condotti di cappe aspiranti rumorose di cucine industriali consentono al tempo stesso di abbattere i rumori esterni dovuti alla turbolenza dell'aria in espulsione e alla risonanza all'interno della cucina.

I silenziatori **RUMOR BLOCK** sono i più performanti del mercato, con valori di abbattimento acustico eccellenti, già dai modelli più piccoli.

L'ampia gamma disponibile risponde a tutte le esigenze dimensionali, nel diametro e lunghezza desiderata.

EN

*In the industrial sector, the **RUMOR BLOCK** acoustic silencers are valuable allies for the sound insulation of air ducts and the ventilation of range hoods in the kitchens of hotels, bars, restaurants, laboratories, as well as for ventilation ducts with the intake or extraction of air, air conditioning ducts, silenced boxes, for both new and existing installations.*

*The **RUMOR BLOCK** facade acoustic silencers for the aeration and ventilation of industrial environments, achieve high performance noise reduction for better comfort at the workplace.*

*The acoustic silencers in the **RUMOR BLOCK** range that are inserted into the ducts of noisy range hoods in industrial kitchens allow at the same time to break down external noise due to the turbulence in air expulsion and the resonance inside of the kitchen.*

*The **RUMOR BLOCK** silencers are the best performing on the market, with excellent sound insulation values, even from the smaller models.*

*The wide range available responds to all dimensional requirements, in the desired diameter and length.*



# GLI SCATOLATI

---

## THE CASES

IT

Silenziatore **Rumor Block** con diffusore airplak per l'isolamento di fori di ventilazione in cucina: **gli scatolati**.

EN

**Rumor Block** silencer with airplak diffuser for the insulation of ventilation holes in the kitchen: **the boxed elements**.

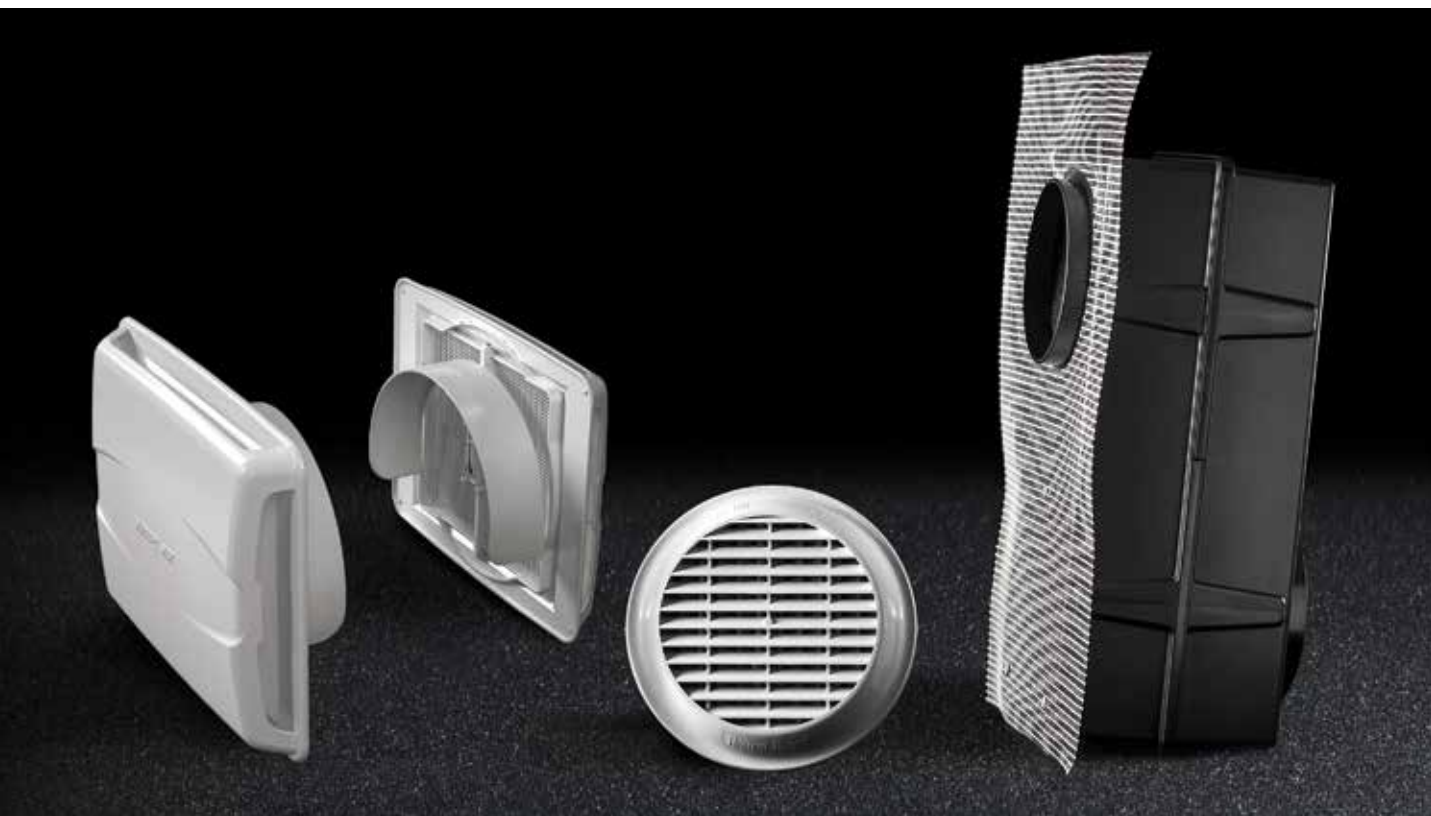

KIT RUMOR BLOCK **N**ORMAL / **S**TRUCTURE  
*KIT RUMOR BLOCK NORMAL / STRUCTURE*

# KIT RUMOR BLOCK NORMAL / STRUCTURE

## KIT RUMOR BLOCK NORMAL / STRUCTURE

**PATENTED**

IT

### KIT RUMOR BLOCK NORMAL

I kit Rumor Block nella configurazione Normal - individuati nello schema dalle frecce verdi - possono contare sulle prestazioni isolanti del rivestimento in poliuretano espanso presente all'interno degli scatolati (n. 3) mentre il tubo (n. 5) non è provvisto di rivestimento interno.

### KIT RUMOR BLOCK STRUCTURE

I kit Rumor Block Structure - individuati nello schema dalle frecce rosse - offrono prestazioni acustiche superiori poiché, oltre al rivestimento in poliuretano espanso contenuto all'interno degli scatolati (n. 3) beneficiano del materiale fonoassorbente (n. 6 e n. 8) inserito all'interno del tubo rigido Ø160 (n. 7 e n. 9).

EN

### KIT RUMOR BLOCK NORMAL

*The Rumor Block kit in Normal configuration - identified in the diagram by the green arrows - can rely on the insulating performance of the polyurethane foam coating present inside the boxed elements (no. 3) while the tube (no. 5) is not provided with an inner coating.*

### KIT RUMOR BLOCK STRUCTURE

*The Rumor Block Structure kits - identified in the diagram by the red arrows - offer superior acoustic performance because, in addition to the polyurethane foam coating contained inside the boxed elements (no. 3) they benefit from sound-absorbing material (no. 6 and no. 8) inserted inside the rigid tube Ø160 (n. 7 and n. 9).*

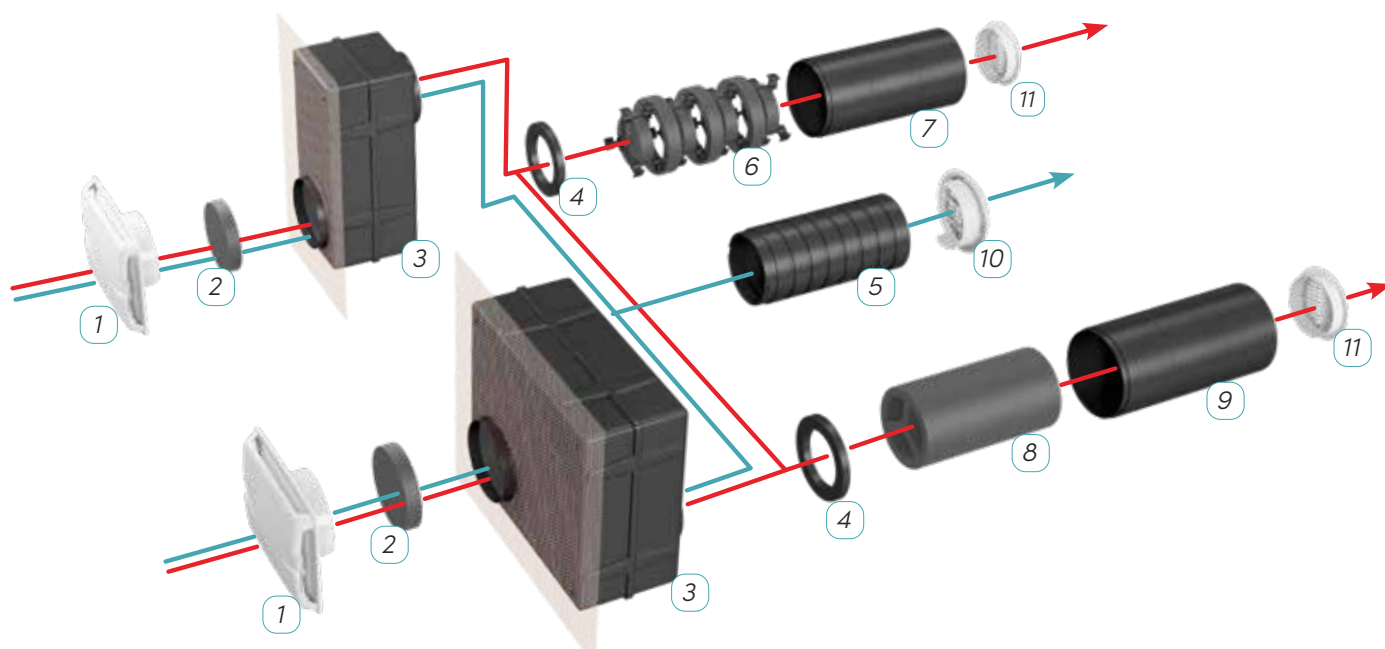

1 Airplak 100 con Aggancio Flex 125/160  
*Airplak 100 with Aggancio Flex 125/160*

2 Tampone antidetriti  
*Anti-Debris Buffer*

3 · Rumor Block RBS 15/35,  
 · Rumor Block RBN 12/29,  
 · Rumor Block RBS 12/20,  
 · Rumor Block RBN 15/15,  
 con rete porta intonaco  
*with plaster mesh netting*

4 Riduzione in ABS tipo Maschio/Femmina da  
 Ø160 a Ø120  
*Reduction in ABS type Male / Female from  
 Ø160 to Ø120*

5 Tubo di prolunga Ø125 componibile  
*Modular extension Tubo Ø125*

6 Struttura Antivento per Tubo 160  
*Windproofing structure for Tubo 160*

7 Tubo rigido con misuratore d'abbattimento del  
 Tubo 160 Antivento  
*Rigid tube with the culling measurer of  
 Tubo 160 Antivento*

8 Struttura fonoassorbente del Tubo Piuma 160  
*Sound absorbing structure of the Tubo Piuma 160*

9 Tubo rigido con misuratore d'abbattimento del  
 Tubo Piuma 160  
*Rigid tube with reduction measurer of the  
 Tubo Piuma 160*

10 Griglia Ø175 con Aggancio Flex 125/160  
*Grating Ø175 with Aggancio Flex 125/160*

11 Griglia Ø175 con imbocco Ø160  
*Grating Ø175 with entrance Ø160*

# VANTAGGI

## ADVANTAGES

### IT

- Elevati valori di **isolamento acustico** fino a  $D_{n,e,w} = 57$  dB (vedi tabella pag. 31)
- **Modulare**, offre molteplici soluzioni per tutte le esigenze
- **Ispezionabili**
- **Dimensioni ridotte**, le più piccole in commercio per i modelli scatolati
- Disponibili anche nell'**esclusivo spessore 120 mm**
- Gli unici dotati di **diffusore AIRPLAK**
- AIRPLAK e Griglia sempre con **Aggancio Flex**

I dispositivi fonoassorbenti RUMOR BLOCK, realizzati in materiale plastico, contengono al loro interno un rivestimento in poliuretano espanso, flessibile, incombustibile, idrorepellente che non disperde fibre e non si polverizza.

I silenziatori scatolati RUMOR BLOCK sono disponibili in diverse tipologie con passaggio d'aria di 100 cm<sup>2</sup> e tutti ispezionabili: n. 4 modelli **NORMAL** e 8 modelli **STRUCTURE** caratterizzati dalle più piccole dimensioni disponibili in commercio e valori di abbattimento acustico  $D_{n,e,w}$  da 49,3 dB fino a 57 dB - di cui 6 modelli (2 NORMAL e 4 STRUCTURE), sono realizzati nell'esclusivo spessore 120 mm, ideati per non tagliare l'isolamento termico e acustico inserito nella parete. I modelli scatolati sono dotati sul lato interno di una rete portaintonaco per facilitare la presa dell'intonaco ed evitare la formazione di crepe.

### EN

- *High **acoustic insulation** values up to  $D_{n,e,w} = 57$  dB (see table p. 31)*
- ***Modular**, offers multiple solutions for all needs*
- ***Inspectable***
- ***Small size**, the smallest on the market for boxed models*
- *Also available in the **exclusive 120 mm thickness***
- *The only ones equipped with **AIRPLAK diffuser***
- *AIRPLAK and Grating always with **Aggancio Flex***

*The RUMOR BLOCK sound-absorbing devices, made of plastic material, contain within them a polyurethane foam coating that is flexible, non-combustible, water-repellent and that does not disperse the fibers and does not pulverize.*

*The RUMOR BLOCK boxed silencers are available in different types with air passage of 100 cm<sup>2</sup> and all inspected: n. 4 **NORMAL** models and 8 **STRUCTURE** models characterized by smaller dimensions available in commercial and noise reduction values  $D_{n,e,w}$  from 49.3 dB to 57 dB - of which 6 models (2 NORMAL and 4 STRUCTURE), are made in the exclusive 120 mm thickness, designed to not cut the thermal and acoustic insulation inserted in the wall. The boxed models are equipped on the inner side with a plaster mesh to facilitate the gripping of the plaster and to avoid the formation of cracks.*

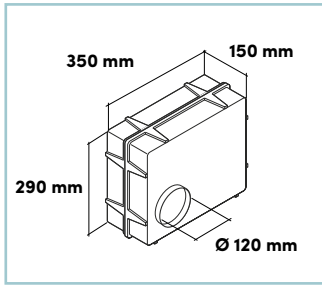
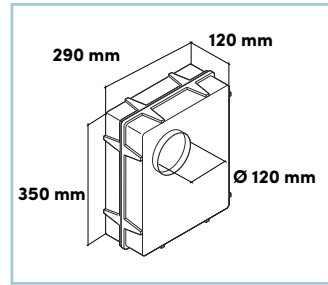
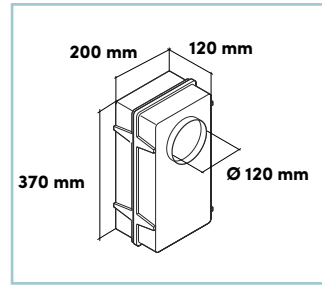
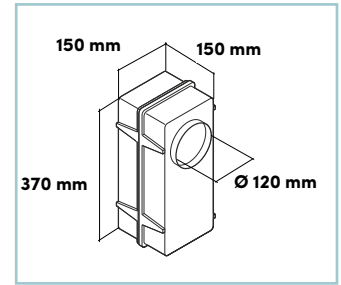

**RUMOR BLOCK  
RBN 15/35**

**RUMOR BLOCK  
RBN 12/29**

**RUMOR BLOCK  
RBN 12/20**

**RUMOR BLOCK  
RBN 15/15**

**Kit Rumor Block**  
**Kit Rumor Block**

CODICE CODE	TIPO TYPE	ABBATTIMENTO ACUSTICO NOISE REDUCTION	MISURA SIZE	PASS. ARIA AIR PASSAGE	PAG LISTINO PRICE LIST PAGE	PZ 
P200001535	KIT RBN 15/35	$D_{n,e,w} = 53,9$ dB (certified)	290x350x150	cm <sup>2</sup> 100	12	1
P200001229	KIT RBN 12/29	$D_{n,e,w} = 50$ dB (certified)	290x350x120	cm <sup>2</sup> 100	12	1
P200001515	KIT RBN 15/15	$D_{n,e,w} = 49,6$ dB (certified)	370x150x150	cm <sup>2</sup> 100	12	1
P200001220	KIT RBN 12/20	$D_{n,e,w} = 49,3$ dB (certified)	370x200x120	cm <sup>2</sup> 100	12	1
P200101535	KIT RB 15/35 <b>Structure fonoassorbente/sound-absorbing</b>	$D_{n,e,w} = 57$ dB (certified)	290x350x150	cm <sup>2</sup> 100	12	1
P200101229	KIT RB 12/29 <b>Structure fonoassorbente/sound-absorbing</b>	$D_{n,e,w} = 53$ dB (certified)	290x350x120	cm <sup>2</sup> 100	12	1
P200101515	KIT RB 15/15 <b>Structure fonoassorbente/sound-absorbing</b>	$D_{n,e,w} = 52$ dB (certified)	370x150x150	cm <sup>2</sup> 100	12	1
P200101220	KIT RB 12/20 <b>Structure fonoassorbente/sound-absorbing</b>	$D_{n,e,w} = 55$ dB (certified)	370x200x120	cm <sup>2</sup> 100	12	1
P200111535	KIT RB 15/35 <b>Structure antivento/windproof</b>	$D_{n,e,w} = 57$ dB (certified)	290x350x150	cm <sup>2</sup> 100	12	1
P200111229	KIT RB 12/29 <b>Structure antivento/windproof</b>	$D_{n,e,w} = 53$ dB (certified)	290x350x120	cm <sup>2</sup> 100	12	1
P200111515	KIT RB 15/15 <b>Structure antivento/windproof</b>	$D_{n,e,w} = 52$ dB (certified)	370x150x150	cm <sup>2</sup> 100	12	1
P200111220	KIT RB 12/20 <b>Structure antivento/windproof</b>	$D_{n,e,w} = 55$ dB (certified)	370x200x120	cm <sup>2</sup> 100	12	1

NB: I modelli **S** hanno un abbattimento sempre maggiore rispetto ai modelli **N**.

*NOTE: The **S** models have a greater reduction than the **N** models.*

Il KIT contiene: Rumor Block scatolato, tubo rigido, Airplak 100 bianco con Aggancio Flex e griglia Ø175 bianca con Aggancio Flex (vedi schema pag. 20).

*The KIT contains: Rumor Block box, rigid tube, white Airplak 100 with Aggancio Flex and white grid Ø175 with Aggancio Flex (see diagram p. 20).*



> POSA IN OPERA SILENZIATORI RUMOR BLOCK  
> RUMOR BLOCK SILENCERS INSTALLATION

## AIRPLAK 100 BIANCO CON AGGANCI FLEX 125/160 WHITE AIRPLAK 100 WITH FLEX 125/160 HITCH

Diffusore interno con passaggio d'aria di 100 cm<sup>2</sup>, progettato per favorire una diffusione omogenea dell'aria ed evitarne il flusso diretto frontale. AIRPLAK 100 è dotato di aperture perimetrali che permettono all'aria proveniente dall'esterno di propagarsi nell'ambiente miscelandosi con quella interna già riscaldata. AIRPLAK 100 può essere fornito con l'esclusivo Aggancio Flex, ad imbocco elastico e geometria variabile per un montaggio rapido e stabile in fori o tubi di diversi diametri.

*Internal diffuser with an air passage of 100 cm<sup>2</sup>, designed to favour a homogeneous diffusion of air and prevent a direct frontal flow. AIRPLAK 100 is equipped with perimeter openings that allow the air coming from the outside to propagate in the environment mixing with the air already heated inside. AIRPLAK 100 can be provided with the exclusive Aggancio Flex, with an elastic entrance of variable geometry for a quick and stable mounting in holes or tubes of different diameters.*



ARCHIESTACOLORI  
DISPONIBILI:  
OPTIONAL COLOURS  
AVAILABLE:

Bianco  
White



Beige  
Beige

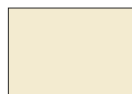

Rame  
Copper

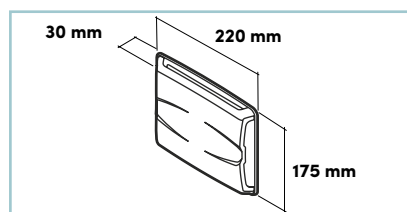

## GRIGLIA Ø175 BIANCA CON AGGANCI FLEX 125/160 WHITE GRID Ø175 WITH FLEX 125/160 HITCH

Griglie realizzate in materiale plastico ABS con separatore laterale di flusso d'aria e rete antinsetti, di diametro 175 mm per passaggio d'aria di 100 cm<sup>2</sup>. Le griglie, coperte da brevetto, possono essere dotate dell'esclusivo Aggancio Flex, ad imbocco elastico e geometria variabile per un montaggio rapido e stabile in fori o tubi di diversi diametri.

*Gratings made of ABS plastic material with lateral separator of airflow and anti-insect net, with a 175 mm diameter for an air passage of 100 cm<sup>2</sup>. The gratings, covered by patent, can be equipped with the exclusive Aggancio Flex, an elastic inlet and of variable geometry for a quick and stable mounting in holes or tubes of different diameters.*



ARCHIESTACOLORI  
DISPONIBILI:  
OPTIONAL COLOURS  
AVAILABLE:

Bianco  
White



Beige  
Beige



Rame  
Copper

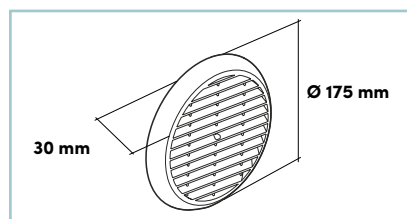

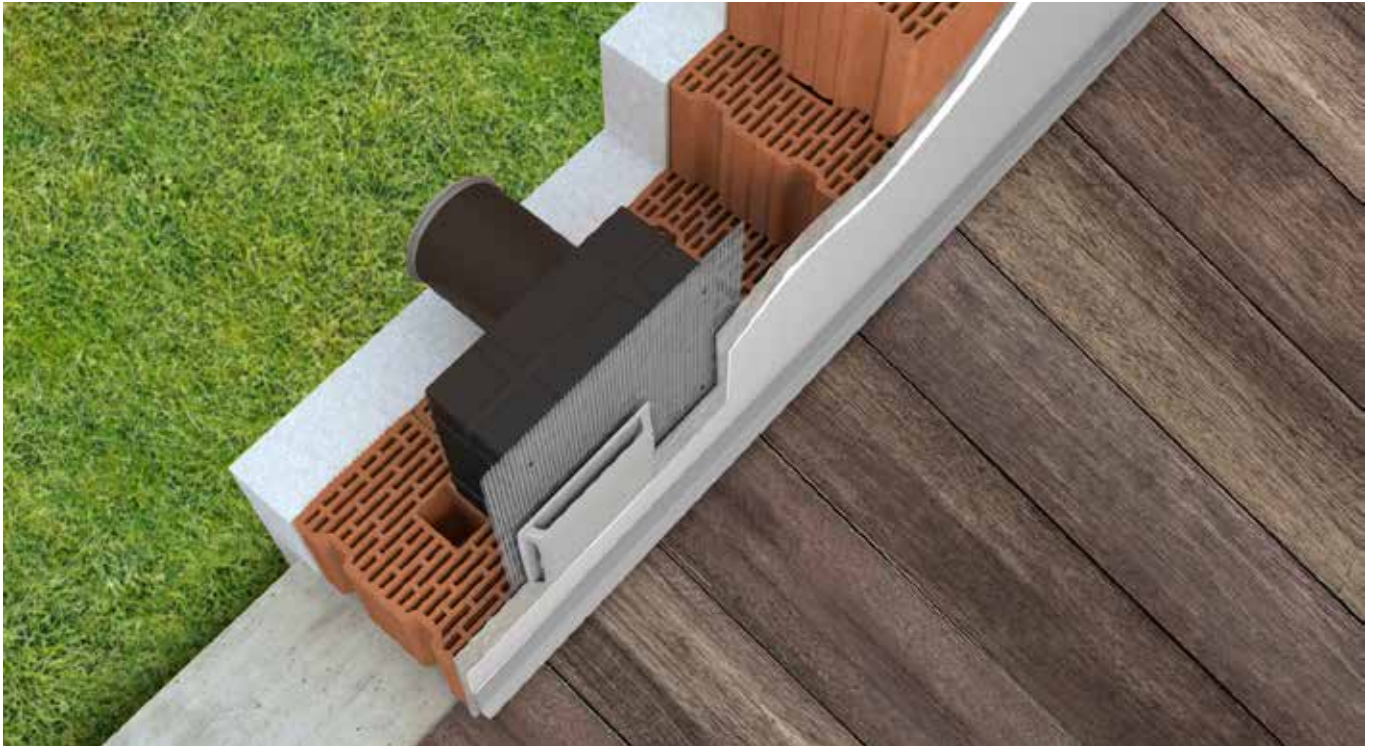

# I TUBOLARI

---

## THE TUBOLAR

KIT TUBO PIUMA 160

*KIT TUBO PIUMA 160*

KIT TUBO ANTIVENTO 160

*KIT TUBO ANTIVENTO 160*

TUBO PIUMA

*TUBO PIUMA*



QUADRO PIUMA  
*QUADRO PIUMA*

KIT TUBO MARMITTA  
*KIT TUBO MARMITTA*

# KIT TUBO PIUMA 160

KIT TUBO PIUMA 160

PATENTED

IT

Silenziatori acustici con diffusore  
airplak per fori di ventilazione in cucina:

**I TUBOLARI.**

EN

Acoustic silencers with airplak diffuser  
for ventilation holes in the kitchen:

**THE TUBULAR.**



1 Airplak 100 con imbocco Ø 160  
*Airplak 100 with inlet Ø 160*

2 Struttura fonoassorbente del Tubo Piuma 160  
*Sound absorbing structure of the Tubo Piuma 160*

3 Tubo rigido con misuratore d'abbattimento  
del Tubo Piuma 160  
*Rigid tube with reduction meter of the Tubo  
Piuma 160*

4 Griglia Ø175 con imbocco Ø 160  
*Grating Ø175 with inlet Ø 160*

## FASCIA RIGHELLO DEL TUBO PIUMA 160

LINE STRIP TUBO PIUMA 160

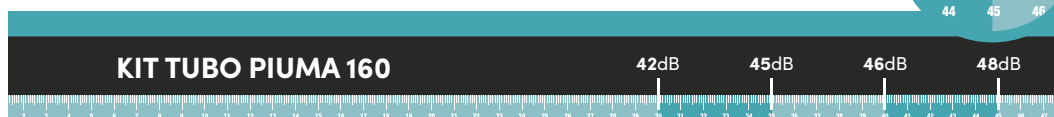

Abbattimento acustico per le diverse lunghezze  
*Noise reduction for different lengths*

ABBATTIMENTO ACUSTICO CERTIFICATO  
CERTIFIED NOISE REDUCTION



36

ETERNO IVICA • VENT

# VANTAGGI

## ADVANTAGES

IT

- **Applicazione rapida** dopo il carotaggio della parete
- **I più performanti** sul mercato con  $D_{n,e,w}$  fino a 48 dB
- **Estraibili, ispezionabili e reinsertibili**
- Gli unici dotati di **diffusore AIRPLAK**
- I più convenienti nel rapporto **qualità/prezzo**

I silenziatori acustici tubolari sono **un'innovativa gamma di prodotti, ideati per la ventilazione di ambienti domestici**, capaci di soddisfare qualsiasi esigenza dimensionale e di posa senza interventi invasivi e con le migliori prestazioni di isolamento acustico della categoria. Essi consentono un passaggio d'aria di 100 cm<sup>2</sup> secondo le norme UNI CIG 7129/2015 e sono coperti da brevetto.

Il Kit tubo piuma 160 è disponibile in diversi modelli, tutti completamente ispezionabili e capaci di inserirsi nel carotaggio eseguito nella parete perimetrale.

I **silenziatori tubolari** presentano una particolarità unica sul mercato: **l'isolamento è esteso a tutto lo spessore della parete** raggiungendo i valori certificati più elevati del settore.

EN

- **Quick application** after the core drilling of the wall
- **The most efficient** on the market with  $D_{n,e,w}$  up to 48 dB
- **Removable, inspectable and reinsertable**
- **The only ones** equipped with **AIRPLAK** diffuser
- **The best savings** in the **quality / price ratio**

The tubular acoustic silencers are **an innovative range of products designed for the ventilation of domestic environments**, capable of satisfying any dimensional requirements and installation without invasive procedures and with the best sound insulation performance in its class. They allow an air passage of 100 cm<sup>2</sup> according to UNI CIG 7129/2015 standards and are covered by the patent. The Tubo Piuma Kit 160 is available in different models, all fully inspected and capable of fitting into the core drilling performed in the perimeter wall.

**The tubular silencers** present a unique feature on the market: **the insulation is extended to the whole thickness of the wall** reaching the highest certified values in the sector.



## Kit tubo piuma 160

### Kit tubo piuma 160

CODICE CODE	TIPO TYPE	ABBATTIMENTO ACUSTICO NOISE REDUCTION	DIAMETRO DIAMETER	LUNGHEZZA STANDARD STANDARD LENGHT	PASS. ARIA AIR PASSAGE	PAG LISTINO PRICE LIST PAGE	PZ 
P203030160	KIT TUBO piuma 160 mm 300*	$D_{n,e,w} = 42 \text{ dB}$ (certified)	Ø 160 mm	300 mm	cm <sup>2</sup> 100	13	1
P203035160	KIT TUBO piuma 160 mm 350*	$D_{n,e,w} = 45 \text{ dB}$ (certified)	Ø 160 mm	350 mm	cm <sup>2</sup> 100	13	1
P203040160	KIT TUBO piuma 160 mm 400*	$D_{n,e,w} = 46 \text{ dB}$ (certified)	Ø 160 mm	400 mm	cm <sup>2</sup> 100	13	1
P203045160	KIT TUBO piuma 160 mm 450*	$D_{n,e,w} = 48 \text{ dB}$ (certified)	Ø 160 mm	450 mm	cm <sup>2</sup> 100	13	1
P203000160	KIT TUBO piuma 160 mm 480*	$D_{n,e,w} = \text{Oltre/Over } 48 \text{ dB}$ (uncertified)	Ø 160 mm	480 mm	cm <sup>2</sup> 100	13	1

L'elemento TUBO PIUMA 160 fonoassorbente ha la stessa dimensione del tubo rigido per insonorizzarlo in tutta la sua lunghezza. Gli abbattimenti acustici certificati sono relativi a 5 lunghezze: 300, 350, 400, 450, 480 mm.

Il KIT contiene: Tubo piuma 160, tubo rigido Ø160, Airplak 100 bianco con imbocco Ø160 e griglia Ø175 bianca con imbocco Ø160 (vedi schema pag. 36).

NB: Il materiale interno del Tubo Piuma 160, la parte fonoassorbente, può essere venduta singolarmente e di diversi diametri (vedi pag. 46).

\* Colore standard accessori "bianco".

*The TUBO PIUMA 160 element has the same sound absorbing rigid tube size for soundproofing throughout its length. The certified acoustic reductions are related to 5 lengths: 300, 350, 400, 450, 480 mm.*

*The kit contains: Tubo Piuma 160, rigid tube Ø160, white Airplak 100 with inlet Ø160 and white grating Ø175 with inlet Ø160 (see diagram p. 36).*

*NOTE: The inner material of Tubo Piuma 160, the sound absorbing part, can be sold individually and with different diameters (see p. 46).*

*\* Standard accessories Colour "White".*

**TUBO  
Ø160**

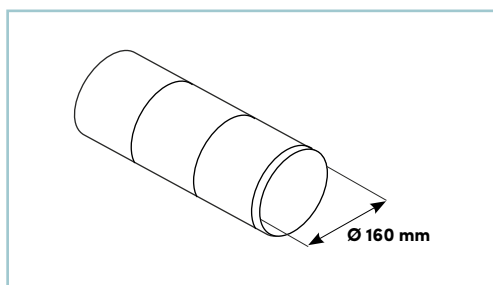

**TUBO PIUMA  
Ø160**

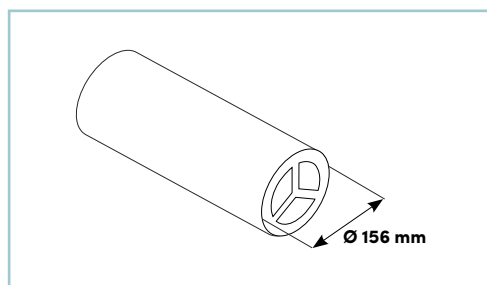



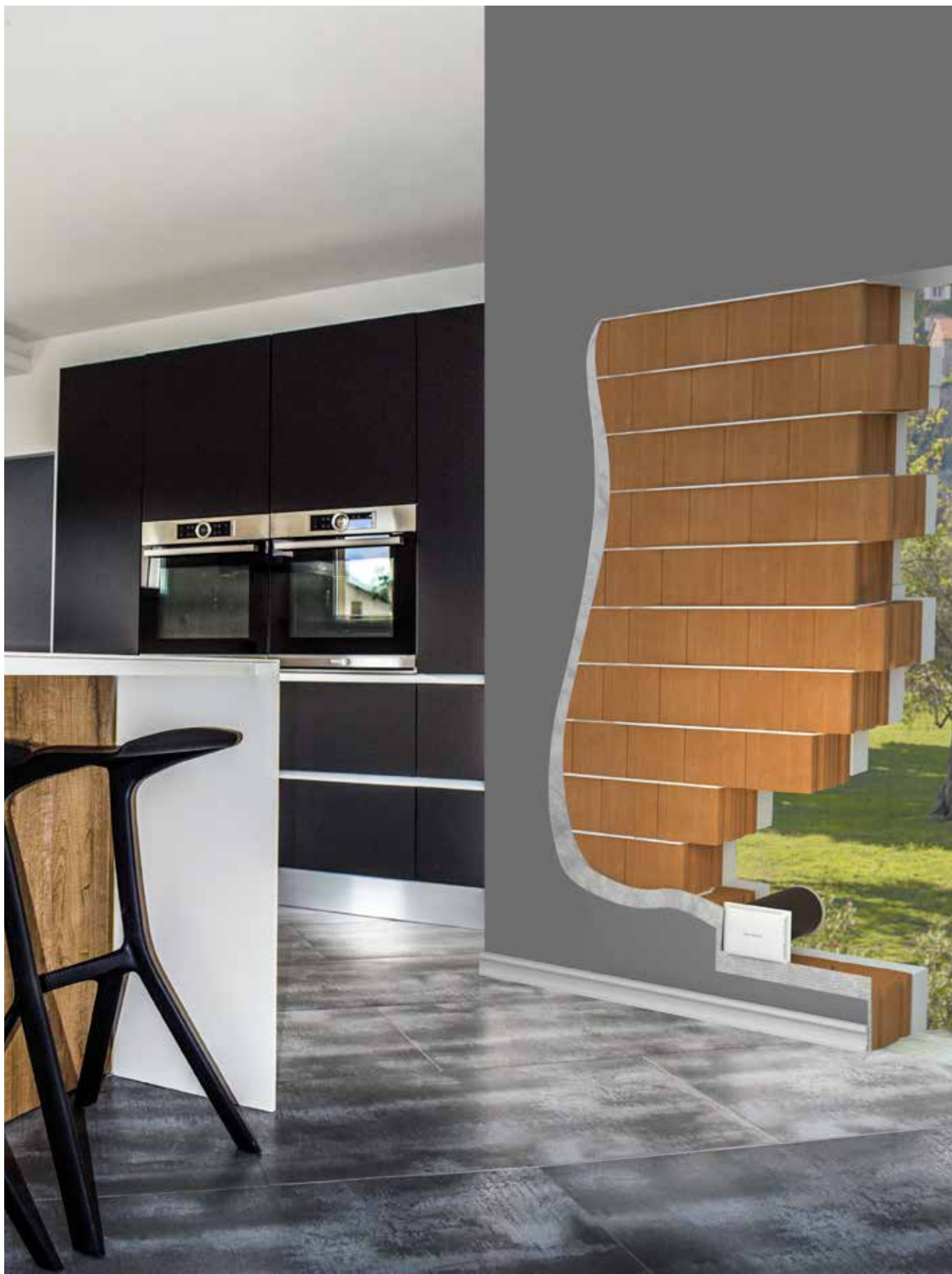

# KIT TUBO 160 ANTIVENTO

*KIT TUBO 160 ANTIVENTO*

**PATENTED**

IT

Silenziatori acustici con diffusore  
airplak per fori di ventilazione in cucina:

**I TUBOLARI.**

EN

*Acoustic silencers with airplak diffuser  
for ventilation holes in the kitchen:*

**THE TUBULAR.**



1 Airplak 100 con imbocco Ø 160  
*Airplak 100 with inlet Ø 160*

2 Struttura fonoassorbente del Tubo 160 Antivento  
*Sound-absorbing structure of the Tubo 160 Antivento*

3 Tubo rigido con misuratore d'abbattimento  
del Tubo 160 Antivento  
*Rigid tube with the Tubo 160 Antivento  
reduction meter*

4 Griglia Ø175 con imbocco Ø 160  
*Grating Ø175 with inlet Ø 160*

## FASCIA RIGHELLO DEL TUBO 160 ANTIVENTO LINE STRIP TUBO 160 ANTIVENTO



Abbattimento acustico per le diverse lunghezze  
*Noise reduction for different lengths*

## ABBATTIMENTO ACUSTICO CERTIFICATO CERTIFIED NOISE REDUCTION



40

ETERNO IVICA · VENT

# VANTAGGI

## ADVANTAGES

IT

- **Applicazione rapida** dopo il carotaggio della parete
- I più **performanti** sul mercato con  $D_n, e, w$  fino a 48 dB
- Disponibile nel **modello antivento** per zone di mare o esposte a forti raffiche
- **Estraibili, ispezionabili e reinseribili**
- Gli unici dotati di **diffusore AIRPLAK**
- I più convenienti nel rapporto **qualità/prezzo**

Il Kit Tubo 160 Antivento è costituito da una struttura in plastica componibile per l'alloggiamento dell'anima fonoassorbente, coperta da brevetto, formata da anelli e dischi in materiale fonoisolante, disposti in modo alternato allo scopo di rallentare la velocità di passaggio dell'aria mantenendo inalterata la sezione libera di passaggio dell'aria stessa (100 cm<sup>2</sup>).

EN

- **Quick application** after the core drilling of the wall
- **The most efficient** on the market with  $D_n, e, w$  up to 48 dB
- Available in the **windproof model** for seaside areas or locations subject to strong gusts
- **Removable, inspectable and reinsertable**
- The only ones equipped with **AIRPLAK diffuser**
- The best savings in the **quality / price ratio**

The Kit Tubo 160 Antivento is made of a plastic modular structure for the sound absorbing of the soul housing, covered by patent, formed by rings and discs in soundproofing material, arranged in an alternating manner in order to slow down the passage of air speed maintaining the free section of the same air passage unchanged (100 cm<sup>2</sup>).

### TUBO Ø160

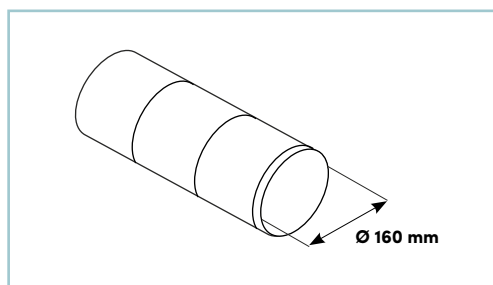

### DISCHI E ANELLI IN POLIURETANO ESPANSO DISCS AND RINGS IN POLYURETHANE FOAM

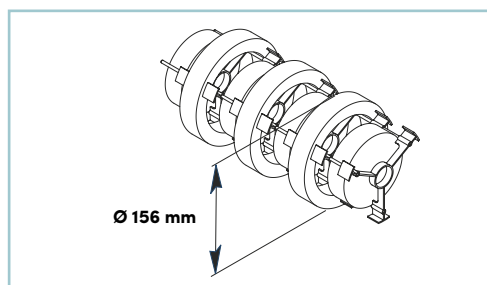

## Kit tubo 160 antivento

### Kit tubo 160 antivento



CODICE CODE	TIPO TYPE	ABBATTIMENTO ACUSTICO NOISE REDUCTION	DIAMETRO DIAMETER	LUNGHEZZA STANDARD STANDARD LENGHT	PASS. ARIA AIR PASSAGE	PAG LISTINO PRICE LIST PAGE	PZ 
P208030160	Kit Tubo 160 Antivento mm 300*	$D_{n,e,w} = 40 \text{ dB}$ (certified)	Ø 160 mm	300 mm	cm <sup>2</sup> 100	14	1
P208035160	Kit Tubo 160 Antivento mm 350*	$D_{n,e,w} = 41 \text{ dB}$ (certified)	Ø 160 mm	350 mm	cm <sup>2</sup> 100	14	1
P208040160	Kit Tubo 160 Antivento mm 400*	$D_{n,e,w} = 44 \text{ dB}$ (certified)	Ø 160 mm	400 mm	cm <sup>2</sup> 100	14	1
P208045160	Kit Tubo 160 Antivento mm 450*	$D_{n,e,w} = 45 \text{ dB}$ (certified)	Ø 160 mm	450 mm	cm <sup>2</sup> 100	14	1
P208000160	Kit Tubo 160 Antivento mm 480*	$D_{n,e,w} = \text{Oltre/Over } 45 \text{ dB}$ (uncertified)	Ø 160 mm	480 mm	cm <sup>2</sup> 100	14	1

L'elemento TUBO PIUMA 160 fonoassorbente ha la stessa dimensione del tubo rigido per insonorizzarlo in tutta la sua lunghezza. Gli abbattimenti acustici certificati sono relativi a 5 lunghezze:

300, 350, 400, 450, 480 mm.

NB: Il KIT contiene: Tubo 160 Antivento, tubo rigido Ø160, Airplak 100 bianco con imbocco Ø160 e griglia Ø175 bianca con imbocco Ø160.

\* Colore standard accessori "bianco".

The TUBO PIUMA 160 element has the same sound absorbing rigid tube size for soundproofing throughout the certified acoustic reductions related to 5 lengths:

300, 350, 400, 450, 480 mm.

NOTE: The Kit contains: Tubo 160 Antivento, rigid tube Ø160, white Airplak 100 with inlet Ø160 and white grating Ø175 with inlet Ø160.

\* Standard accessories Colour "White".

## AIRPLAK 100 CON IMBOCCO Ø160 - PER KIT TUBO PIUMA E KIT TUBO ANTIVENTO

### AIRPLAK 100 WITH INLET Ø160 - FOR KIT TUBO PIUMA AND KIT ANTIVENTO

Diffusore interno con passaggio d'aria di 100 cm<sup>2</sup>, progettato per favorire una diffusione omogenea dell'aria ed evitarne il flusso diretto frontale.

AIRPLAK 100 è dotato di aperture perimetrali che permettono all'aria proveniente dall'esterno di propagarsi nell'ambiente miscelandosi con quella interna già riscaldata. Sul lato interno del diffusore è presente un imbocco circolare a diametro fisso, per l'inserimento del diffusore stesso nel tubo o foro.

Internal diffuser with an air passage of 100 cm<sup>2</sup>, designed to favour a homogeneous diffusion of air and prevent a direct frontal flow.

AIRPLAK 100 is equipped with perimeter openings that allow the air coming from the outside to propagate in the environment mixing with the air already heated inside. On the inner side of the diffuser there is a circular inlet with a fixed diameter, for the insertion of the diffuser itself in the tube or hole.



ARCHIESTA COLORI  
DISPONIBILI:  
OPTIONAL COLOURS  
AVAILABLE:

Bianco  
White



Beige  
Beige

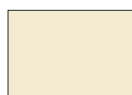

Rame  
Copper

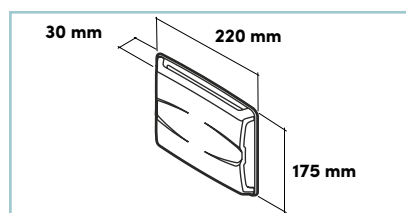

**GRIGLIA Ø175 CON IMBOCCO Ø160 - PER KIT TUBO PIUMA E KIT TUBO ANTIVENTO**  
**GRATING Ø175 WITH INLET Ø160 - FOR KIT TUBO PIUMA AND KIT ANTIVENTO**

Griglie realizzate in materiale plastico ABS con separatore laterale di flusso d'aria e rete antinsetti, di diametro 175 mm per passaggio d'aria di 100 cm<sup>2</sup>.

Le griglie, coperte da brevetto, sono dotate di imbocco circolare diametro 160 mm.

*Gratings made of ABS plastic material with lateral separator of airflow and anti-insect net, with a 175 mm diameter for an air passage of 100 cm<sup>2</sup>.*

*The gratings, covered by patent, are equipped with a circular inlet diameter of 160 mm.*



ARCHIESTACOLORI  
DISPONIBILI:  
OPTIONAL COLOURS  
AVAILABLE:

Bianco  
White



Beige  
Beige

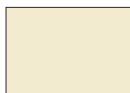

Rame  
Copper

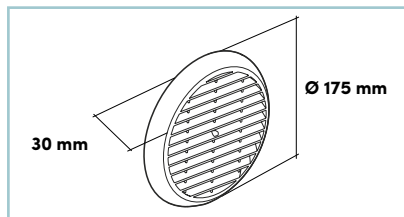

# TUBO PIUMA

## TUBO PIUMA

IT

### **Silenziatori per fori e condotti di ventilazione e aerazione in ambienti civili e industriali: TUBI PIUMA.**

Tubo Piuma è ideale per l'abbattimento di rumori che transitano all'interno delle canalizzazioni di espulsione d'aria delle cappe aspiranti e dei bagni, rumori che possono provenire dall'esterno, dalle altre unità abitative o generati dagli impianti di aspirazione forzata. In tutti questi casi è sufficiente inserire il Tubo Piuma nei condotti nuovi o esistenti per eliminare tali problematiche. Inoltre essendo flessibile il Tubo Piuma può superare curve a 90°, per poi riposizionarsi nella forma originale una volta messo in sede. Tubo Piuma è disponibile in diversi diametri.

EN

### ***Silencers for ventilation and aeration ducts and holes in civil and industrial environments: PIUMA TUBES.***

*Tubo Piuma is ideal for the reduction of noise transiting inside the air discharge ducts of range hoods and bathrooms, noises that may come from outside, from other living units or generated by forced aspiration installation. In all these cases simply insert the Tubo Piuma in new or existing ducts to eliminate these problems. Also, being flexible, Tubo Piuma can exceed curvatures of 90 °, and then reposition itself to its original shape once put into place. Piuma Tubo is available in various diameters.*

# VANTAGGI

## ADVANTAGES

IT

- Non necessita di opere murarie
- Facilita' di installazione
- Basso costo
- Ottimi risultati
- Flessibilita' supera anche curve a 90°
- Ideale per l'inserimento nelle prese d'aria delle cucine già esistenti

EN

- *It does not require masonry work*
- *Easy to install*
- *Low cost*
- *Great results*
- *Flexibility exceeds even 90 ° bends*
- *Ideal for insertion into air vents of existing kitchens*

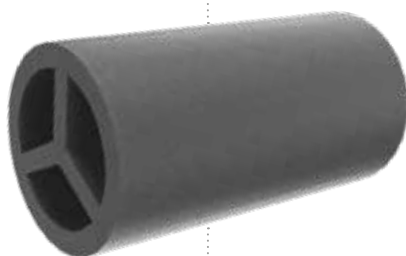

Silenziatori acustici da inserire in condotti di aerazione, ventilazione e condizionamento nuovi o già esistenti, in cucine e bagni di civili abitazioni, alberghi, ristoranti, bar, laboratori, box silenti per compressori. Per evitare opere murarie si consiglia l'utilizzo dei silenziatori Tubo Piuma disponibili in diversi diametri: 80-90-100-110-120-140-150-160-200-250-300 mm.

*Acoustic silencers to be inserted in air ducts, ventilation and new or existing air conditioning, in kitchens and bathrooms of civil environments, hotels, restaurants, bars, workshops, silent boxes for compressors. To avoid masonry work we recommend the use of Tubo Piuma silencers available in several diameters: 80-90-100-110-120-140-150-160-200-250-300 mm.*



> POSA IN OPERA SILENZIATORI ACUSTICI TUBO PIUMA PER AMBIENTI CIVILI  
> *TUBO PIUMA ACOUSTIC SILENCERS INSTALLATION FOR CIVIL ENVIRONMENTS*

LA NOSTRA GAMMA DI SILENZIATORI TUBOLARI TUBI PIUMA SI ESTENDE A FORI DI QUALSIASI  
 DIAMETRO, IL DIAMETRO Ø 160 È DISPONIBILE ANCHE IN KIT  
 OUR RANGE OF TUBO PIUMA TUBULAR SILENCERS EXTEND TO HOLES IN ANY DIAMETER,  
 THE DIAMETER Ø 160 IS ALSO AVAILABLE IN KIT

TUBO Ø80

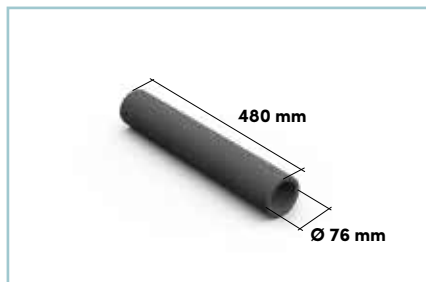

TUBO Ø90

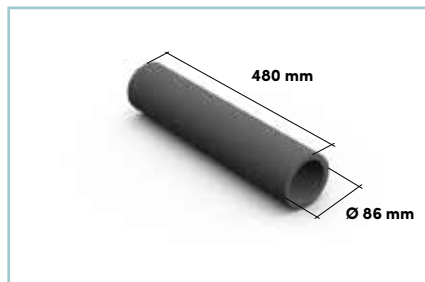

TUBO Ø100

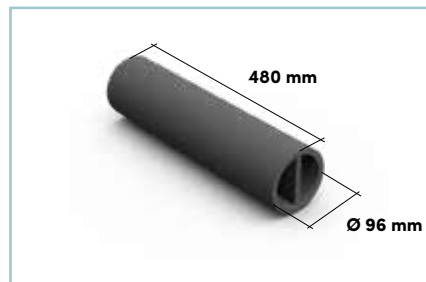

TUBO Ø110

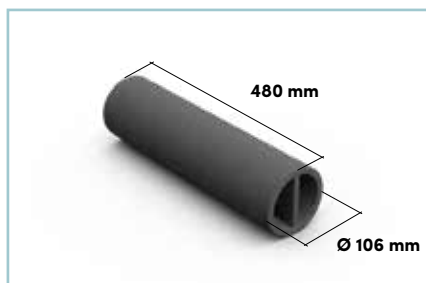

TUBO Ø120

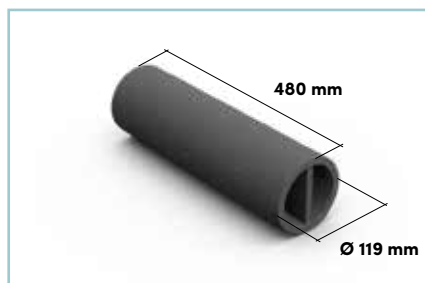

TUBO Ø140

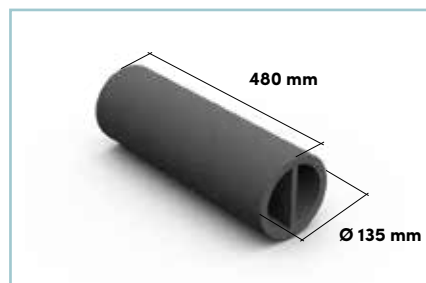

TUBO Ø150

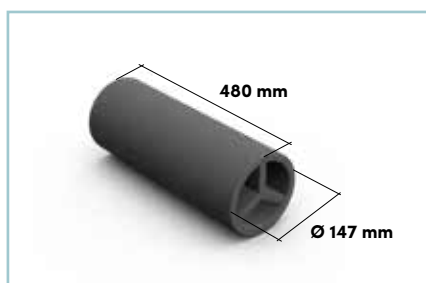

TUBO Ø160

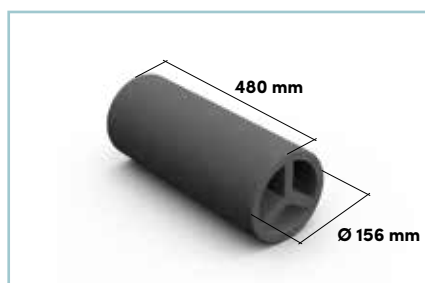

TUBO Ø200

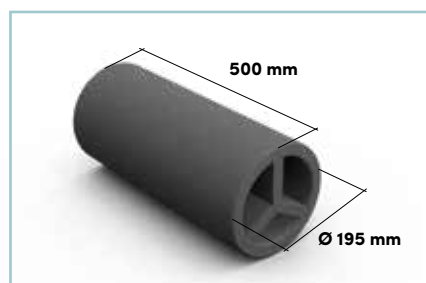

TUBO Ø250

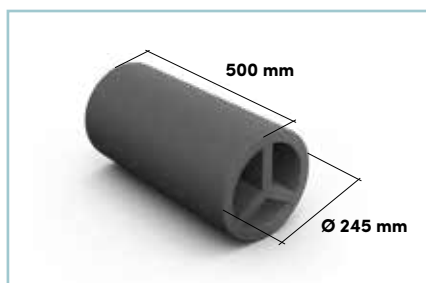

TUBO Ø300

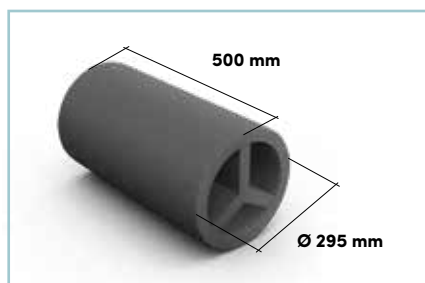



## POSA IN OPERA DEL TUBO PIUMA INSTALLATION OF TUBO PIUMA

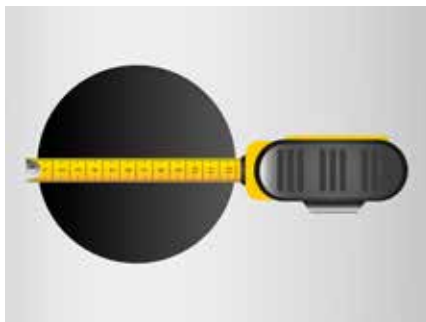

Rimuovere la griglia e misurare il diametro del foro e scegliere il Tubo Piuma adeguato.

*Remove the grating and measure the diameter of the hole and choose the proper Tubo Piuma.*



Spingere con forza il Tubo Piuma all'interno del condotto affinché superi la curvatura: grazie alla sua flessibilità il Tubo Piuma riesce a superare anche angoli a 90°.

*Firmly push the Tubo Piuma within the duct so that it exceeds the curvature: thanks to its flexibility Tubo Piuma manages to overcome even angles of 90°.*



Una volta superata la curvatura il Tubo Piuma si assesta naturalmente all'interno del condotto recuperando la sua forma originale.

*Once through the curvature, the Tubo Piuma settles naturally inside the duct recovering its original shape.*

**Tubo Piuma 160****Tubo Piuma 160**

<b>CODICE</b> <i>CODE</i>	<b>TIPO</b> <i>TYPE</i>	<b>ABBATTIMENTO ACUSTICO</b> <i>NOISE REDUCTION</i>	<b>DIAMETRO</b> <i>DIAMETER</i>	<b>LUNGHEZZA STANDARD</b> <i>STANDARD LENGHT</i>	<b>PASS. ARIA</b> <i>AIR PASSAGE</i>	<b>PAG LISTINO</b> <i>PRICE LIST PAGE</i>	<b>PZ</b> 
P210010160.30	TUBO PIUMA 160 mm 300	Dn,e,w = <b>42 dB</b> (certified)	Ø 160 mm	300 mm	cm <sup>2</sup> 100	15	1
P210010160.35	TUBO PIUMA 160 mm 350	Dn,e,w = <b>45 dB</b> (certified)	Ø 160 mm	350 mm	cm <sup>2</sup> 100	15	1
P210010160.40	TUBO PIUMA 160 mm 400	Dn,e,w = <b>46 dB</b> (certified)	Ø 160 mm	400 mm	cm <sup>2</sup> 100	15	1
P210010160.45	TUBO PIUMA 160 mm 450	Dn,e,w = <b>48 dB</b> (certified)	Ø 160 mm	450 mm	cm <sup>2</sup> 100	15	1
P210010160	TUBO PIUMA 160 mm 480	Dn,e,w = Oltre/ <i>Over</i> <b>48 dB</b> (uncertified)	Ø 160 mm	480 mm	cm <sup>2</sup> 100	15	1

**Tubo Piuma****Tubo Piuma**

<b>CODICE</b> <i>CODE</i>	<b>TIPO</b> <i>TYPE</i>	<b>ABBATTIMENTO ACUSTICO</b> <i>NOISE REDUCTION</i>	<b>DIAMETRO</b> <i>DIAMETER</i>	<b>LUNGHEZZA STANDARD</b> <i>STANDARD LENGHT</i>	<b>PASS. ARIA</b> <i>AIR PASSAGE</i>	<b>PAG LISTINO</b> <i>PRICE LIST PAGE</i>	<b>PZ</b> 
P210010080	TUBO PIUMA 80	Dn,e,w = <b>49 dB</b> (certified)	Ø 80 mm	480 mm	cm <sup>2</sup> 19,6	15	1
P210010090	TUBO PIUMA 90	Dn,e,w = <b>45 dB</b> (certified)	Ø 90 mm	480 mm	cm <sup>2</sup> 28	15	1
P210010100	TUBO PIUMA 100	Dn,e,w = <b>47 dB</b> (certified)	Ø 100 mm	480 mm	cm <sup>2</sup> 28	15	1
P210010110	TUBO PIUMA 110	Dn,e,w = <b>43 dB</b> (certified)	Ø 110 mm	480 mm	cm <sup>2</sup> 34	15	1
P210010120	TUBO PIUMA 120	Dn,e,w = <b>49 dB</b> (certified)	Ø 120 mm	480 mm	cm <sup>2</sup> 34	15	1
P210010140	TUBO PIUMA 140	Dn,e,w = <b>41 dB</b> (certified)	Ø 140 mm	480 mm	cm <sup>2</sup> 58	15	1
P210010150	TUBO PIUMA 150	Dn,e,w = <b>42 dB</b> (certified)	Ø 150 mm	480 mm	cm <sup>2</sup> 78	15	1
P210010200	TUBO PIUMA 200	Dn,e,w = <b>38 dB</b> (certified)	Ø 200 mm	500 mm	cm <sup>2</sup> 145	15	1
P210010250	TUBO PIUMA 250	Dn,e,w = <b>39 dB</b> (certified)	Ø 250 mm	500 mm	cm <sup>2</sup> 225	15	1
P210010300	TUBO PIUMA 300	Dn,e,w = <b>33 dB</b> (certified)	Ø 300 mm	500 mm	cm <sup>2</sup> 327	15	1

NB.: Questi valori di abbattimento acustico sono sempre validi per Ø compresi tra 80 e 200 e con lunghezza Tubo Piuma non inferiore a 400 mm.

Per valori con lunghezze diverse contattare la sede.

Per i modelli tubo Piuma Ø 250 e Ø 300 è stata certificata la misura da 500 mm.

*NOTE: These noise reduction values are always valid for Ø including between 80 and 200 and with Tubo Piuma length no less than 400 mm.*

*For values with different lengths please contact the headquarters.*

*For Tubo Piuma models Ø250 and Ø300 it has been certified by the measurement of 500 mm.*



# QUADRO PIUMA

## QUADRO PIUMA

IT

### **Silenziatori per condotti di ventilazione e aerazione in ambienti industriali: QUADRI PIUMA.**

Quadro Piuma è un silenziatore per condotti di aerazione e ventilazione industriali studiato per l'inserimento in tubi a sezione quadrata o rettangolare e formato da elementi componibili che lo rendono estremamente versatile nel dimensionamento.

EN

### ***Silencers for ventilation and aeration ducts in industrial environments: QUADRI PIUMA.***

*Quadro Piuma is a silencer for industrial ventilation and aeration ducts and designed for insertion into square or rectangular section tubes and formed by modular elements that make it extremely versatile in sizing.*



# VANTAGGI

## ADVANTAGES

IT

- Non richiede opere murarie
- Facilita' di installazione
- Basso costo
- Ottimi risultati
- Flessibilità supera anche curve a 90°

EN

- It does not require masonry work
- Easy to install
- Low cost
- Great results
- Flexibility exceeds even 90 ° bends



Elementi fonoassorbenti di forma quadrata o rettangolare realizzati in poliuretano espanso flessibile, studiati per l'isolamento acustico di condotti di aerazione e ventilazione industriali di nuova installazione o già esistenti.

Gli elementi, disponibili in due formati 150x200 mm e 200x200 mm, sono utilizzabili singolarmente o in abbinamento per adattarsi al formato richiesto.

*Sound absorbing elements of a square or rectangular shape made of flexible polyurethane foam, designed for the acoustic insulation of industrial ventilation and aeration ducts in new or existing installations.*

*The elements, which are available in two sizes 150x200 mm and 200x200 mm, are used individually or in combination to adapt to the required format.*



> POSA IN OPERA SILENZIATORI ACUSTICI QUADRO PIUMA PER AMBIENTI INDUSTRIALI  
> INSTALLATION OF QUADRO PIUMA ACOUSTIC SILENCERS FOR INDUSTRIAL ENVIRONMENTS

**MODELLO 200x200 mm**  
**ABBATTIMENTO ACUSTICO**  
**39 dB PASS. ARIA cm<sup>2</sup> 187,5**  
 MODEL 200x200 mm NOISE  
 REDUCTION 39 dB PASS. AIR cm<sup>2</sup>  
 187.5

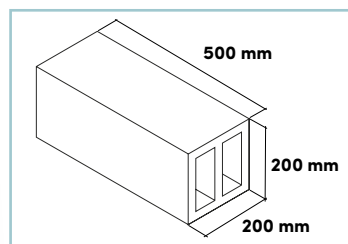

**MODELLO 150x200 mm**  
**ABBATTIMENTO ACUSTICO**  
**44 dB PASS. ARIA cm<sup>2</sup> 125**  
 MODEL 150x200 mm NOISE  
 REDUCTION 44 dB PASS. AIR  
 cm<sup>2</sup> 125

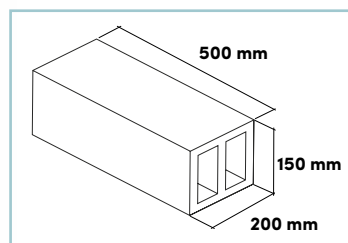

**VERSATILI E COMPLEMENTARI:**  
**DUE FORMATI PER INFINITE**  
**COMBINAZIONI DIMENSIONALI**  
 VERSATILE AND COMPLEMENTARY:  
 TWO SIZES FOR INFINITE  
 DIMENSIONAL COMBINATIONS

Sezione 150x200 mm  
 Section 150x200 mm

Sezione 200x200 mm  
 Section 200x200 mm



**ESEMPI DI ABBINAMENTO:**  
 EXAMPLES OF COMBINATIONS:

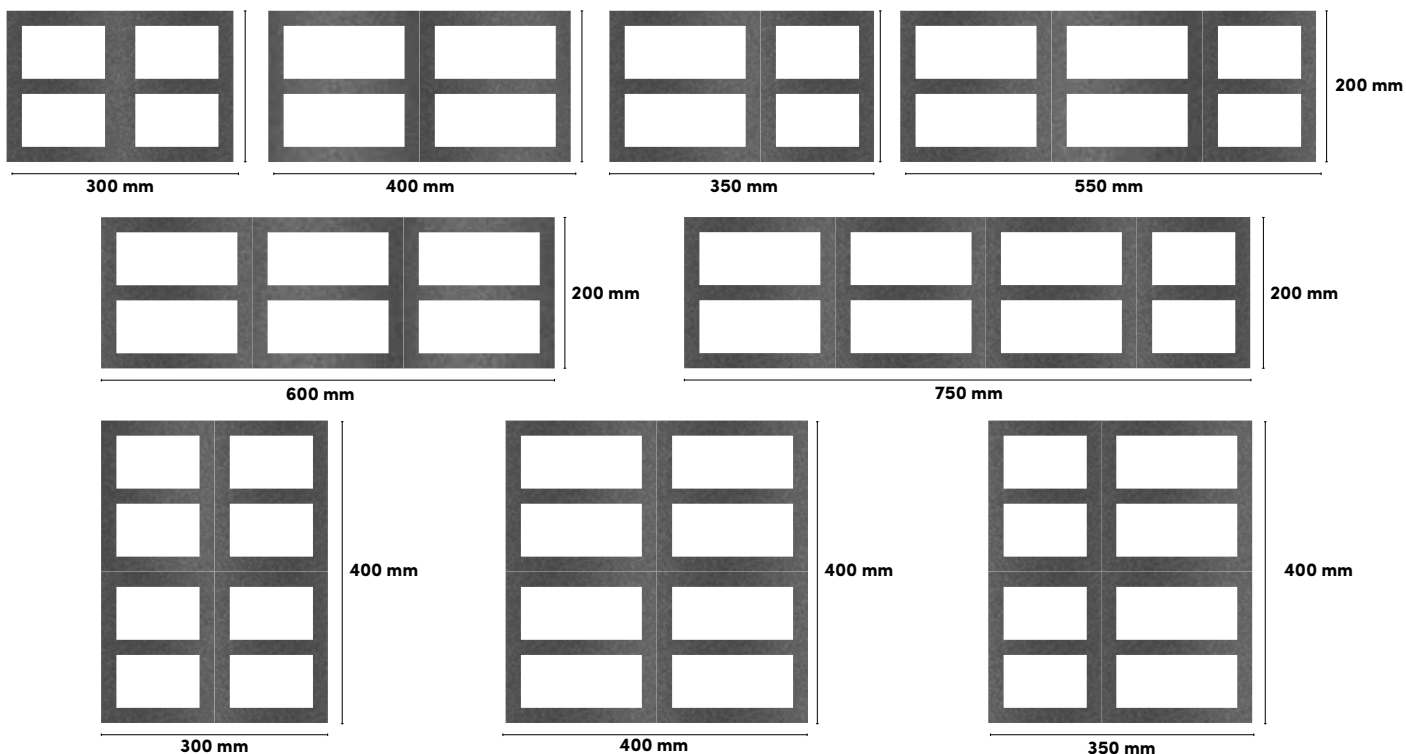

## Quadro Piuma

### Quadro Piuma

CODICE CODE	TIPO TYPE	ABBATTIMENTO ACUSTICO NOISE REDUCTION	BASE BASE	ALTEZZA HEIGHT	LUNGHEZZA STANDARD STANDARD LENGHT	PAG LISTINO PRICE LIST PAGE	PZ 
P210009015	QUADRO PIUMA MM 150X200 L.500	$D_{n,e,w} = 44 \text{ dB}$ (certified)	150 mm	200 mm	500 mm	16	1
P210009020	QUADRO PIUMA MM 200X200 L.500	$D_{n,e,w} = 39 \text{ dB}$ (certified)	200 mm	200 mm	500 mm	16	1

NB.: Questi valori si intendono sempre validi con lunghezza Quadro Piuma non inferiore a 500 mm, per valori con lunghezza diversa contattare la sede.

*NOTE: These values are always considered valid with Quadro Piuma lengths no less than 500 mm, for values with different lengths please contact the headquarters.*

### POSA IN OPERA DEL QUADRO PIUMA INSTALLATION OF THE QUADRO PIUMA



Rimuovere la griglia e misurare le dimensioni del foro e scegliere il Quadro Piuma adeguato.

*Remove the grating and measure the size of the hole and choose the proper Quadro Piuma.*



Inserire Quadro Piuma, configurato nell'opportuna dimensione all'interno del condotto spingendolo fino a raggiungere il posizionamento desiderato.

*Insert Quadro Piuma, configured in the required size within the duct by pushing it until it reaches the desired position.*



Ricollocare la griglia o il diffusore all'imbocco del condotto.

*Replace the grating or the diffuser at the mouth of duct*

# KIT TUBO MARMITTA

## KIT TUBO MARMITTA

IT

**Silenziatori per condotti di aerazione e ventilazione in ambienti civili e industriali: TUBI MARMITTA.**

**Comfort acustico e aerazione ottimale in bagni con condotti di aspirazione collettivi.**

I silenzianti acustici Tubo Marmitta sono stati studiati per garantire una sezione di passaggio d'aria superiore o equivalente a quella del condotto esistente da silenziare.

Tubo Marmitta è costituito da un silenziatore tubolare e due terminali che lo raccordano al diametro della tubazione esistente.

EN

***Silencers for aeration and ventilation ducts in civil and industrial environments: TUBI MARMITTA.***

***Acoustic comfort and optimal aeration in bathrooms with collective aspiration ducts.***

*The Tubo Marmitta acoustic silencers have been studied to ensure a section of air passage superior or equivalent to that of the existing conduit to be silenced.*

*The Tubo Marmitta consists of a tubular silencer and two terminals that link up to the diameter of the existing conduit.*





# VANTAGGI

## ADVANTAGES

### IT

- Facilità di installazione
- Sezione di aerazione e ventilazione incrementata o costante
- Versatilità di impiego
- Universale
- Elevate prestazioni fonoisolanti

Il Tubo Marmitta, con anima in Tubo Piuma si inserisce interrompendo il canale esistente e raccordandolo ai diametri opportuni in modo da incrementare o mantenere la sezione di passaggio dell'aria, con prestazioni di abbattimento acustico elevate.

### EN

- Easy to install
- Ventilation and aeration area increased or constant
- Versatility of use
- Universal
- High-performance soundproofing

*The Tubo Marmitta, with a core of Tubo Piuma, is inserted interrupting the existing channel and linking it to the appropriate diameters in order to increase or maintain the air flow cross-section, with high performance in acoustic reduction.*

### ESPLOSO KIT TUBO MARMITTA ELEMENTS OF KIT TUBO MARMITTA



1 Raccordo  
Fitting

2 Tubo rigido con tubo piuma all'interno  
Rigid tube with tubo piuma inside

MISURE KIT TUBO MARMITTA  
MEASURES OF KIT TUBO MARMITTA



TM 100

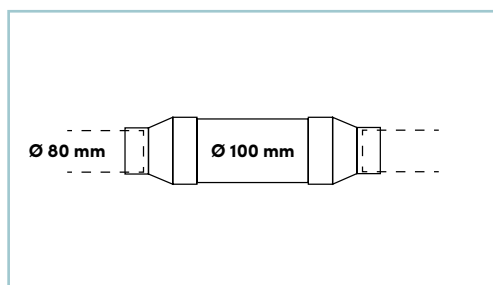

TM 125

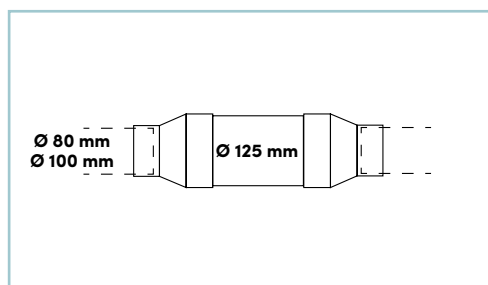

TM 140

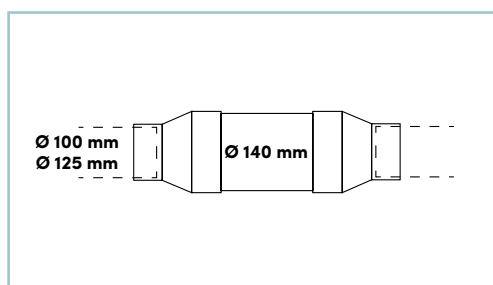

TM 160

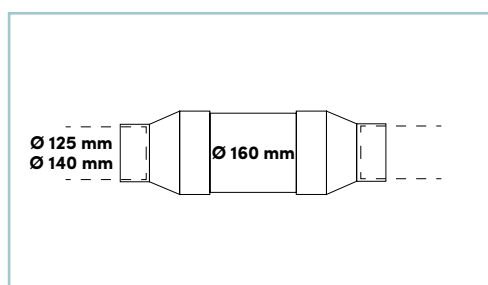

TM 200

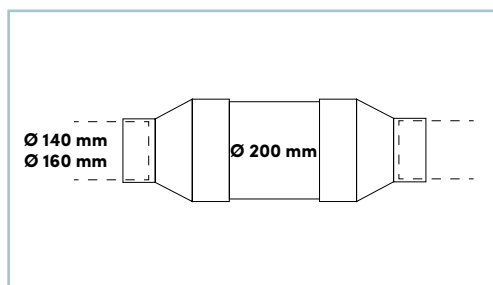

TM 250

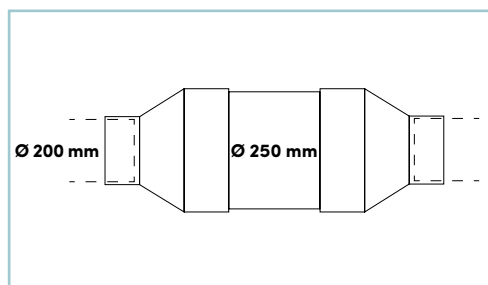

## FASI DI POSA IN OPERA

### PHASES OF INSTALLATION

- 1 Scegliere il silenziatore acustico Tubo Marmitta, in base al diametro del tubo esistente da silenziare.  
*Choose the Tubo Marmitta acoustic silencer, according to the diameter of the existing tube to be muted.*
- 2 Interrompere la tubazione del condotto d'aria da silenziare e posizionare i raccordi in prossimità delle due estremità\*.  
*Stop the piping of the air duct to be muted and position the connectors in the vicinity of the two ends\*.*
- 3 Scegliere il silenziatore acustico Tubo Marmitta, in base al diametro del tubo esistente da silenziare.  
*Choose the Tubo Marmitta acoustic silencer, according to the diameter of the existing tube to be muted.*
- 4 Interporre il Tubo Marmitta nel diametro scelto e raccordarlo agli elementi già posizionati\*.  
*Interpose the Tubo Marmitta in the chosen diameter and connect it to the elements already positioned\*.*

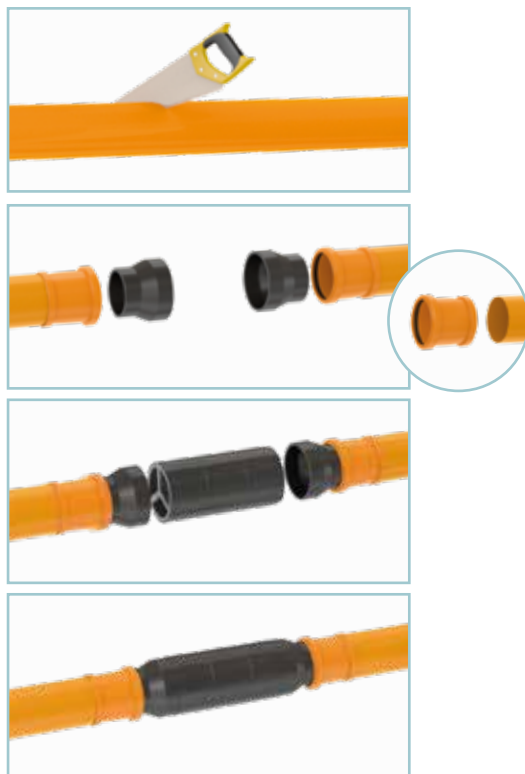

\* In mancanza del bicchiere collegare la riduzione al tubo con un manicotto femmina/femmina  
\* In the absence of the glass connect the reduction to the tube with a female / female sleeve

## Kit tubo marmitta

### Kit tubo marmitta

CODICE CODE	TIPO TYPE	ABBATTIMENTO ACUSTICO NOISE REDUCTION	DIAMETRO DIAMETER	LUNGHEZZA STANDARD STANDARD LENGTH	PASS. ARIA AIR PASSAGE	PAG LISTINO PRICE LIST PAGE	PZ 
P210030100	KIT TM 100 L480	$D_{n,e,w} = 47 \text{ dB}$ (certified)	Ø 80 mm	680 mm	cm <sup>2</sup> 28	17	1
P210030125	KIT TM 125 L480	$D_{n,e,w} = 49 \text{ dB}$ (certified)	Ø 80 mm	680 mm	cm <sup>2</sup> 34	17	1
P210030126	KIT TM 125 L480	$D_{n,e,w} = 49 \text{ dB}$ (certified)	Ø 100 mm	680 mm	cm <sup>2</sup> 34	17	1
P210030140	KIT TM 140 L480	$D_{n,e,w} = 41 \text{ dB}$ (certified)	Ø 100 mm	680 mm	cm <sup>2</sup> 58	17	1
P210030142	KIT TM 140 L480	$D_{n,e,w} = 41 \text{ dB}$ (certified)	Ø 125 mm	680 mm	cm <sup>2</sup> 58	17	1
P210030160	KIT TM 160 L480	$D_{n,e,w} = 48 \text{ dB}$ (certified)	Ø 125 mm	680 mm	cm <sup>2</sup> 100	17	1
P210030161	KIT TM 160 L480	$D_{n,e,w} = 48 \text{ dB}$ (certified)	Ø 140 mm	680 mm	cm <sup>2</sup> 100	17	1
P210030200	KIT TM 200 L480	$D_{n,e,w} = 38 \text{ dB}$ (certified)	Ø 140 mm	680 mm	cm <sup>2</sup> 145	17	1
P210030201	KIT TM 200 L480	$D_{n,e,w} = 38 \text{ dB}$ (certified)	Ø 160 mm	680 mm	cm <sup>2</sup> 145	17	1
P210030250	KIT TM 250 L480	$D_{n,e,w} = 39 \text{ dB}$ (certified)	Ø 200 mm	680 mm	cm <sup>2</sup> 225	17	1

NB.: Questi valori si intendono sempre validi con lunghezza Tubo Marmitta non inferiore a 680 mm, per valori con lunghezza diversa contattare la sede.

NOTE: These values are always considered valid with a Tubo Marmitta length not less than 680 mm, for values with different lengths please contact the headquarters.

# ACCESSORI

---

## ACCESSORIES

IT

La gamma di accessori per il completamento dei sistemi di aerazione silenziata e ventilazione naturale.

EN

*Range of accessories for the completion of natural silenced aeration and ventilation systems.*



AGGANCIO  
*FLEX*

GRIGLIA  
*GRATING*

ESALATORE  
*VENT*

AIRPLAK  
*AIRPLAK*

# AGGANCIO

## FLEX

PATENTED

### Dettaglio flessibilità aggancio flex

#### Aggancio flex flexibility detail

L'imbocco elastico realizzato in materiale sintetico particolarmente resistente e flessibile si adatta alla circonferenza interna del tubo o foro in cui va inserito interessandola per oltre la sua metà.

*The elastic inlet made of particularly resistant and flexible synthetic material fits the circumference of the inner tube or hole in which it is inserted pertaining to more than half of it.*



### Dettaglio rotazione aggancio flex

#### Aggancio flex rotation detail

L'unica molla in commercio che consente lo spostamento ed il posizionamento decentrato della griglia da applicare:

- ad un foro eseguito troppo vicino al soffitto o ad una parete
- per coprire eventuali sbrecciature della muratura
- per riuscire a coprire con il posizionamento mirato dell'AIRPLAK tinteggiature non ripristinate.

Il montaggio si esegue semplicemente allentando la vite di collegamento alla griglia, facendo scorrere la molla lungo l'asola a slitta del braccetto e riavvitando.

*The only spring on the market that allows the shifting and decentralized positioning of the grating to be applied:*

- to a hole made too close to the ceiling or to a wall
- to cover any chipped masonry
- to be able to cover with the targeted placement of the AIRPLAK non restored paint

*The mounting is accomplished by simply loosening the screw connection to the grating, by sliding the spring along the sled buttonhole of the arm and screwing.*

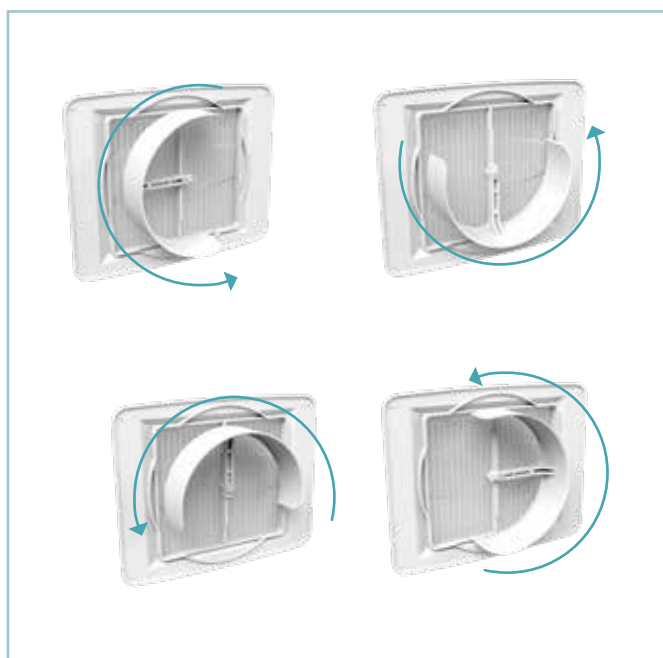

### Dettaglio spostamento aggancio flex

#### Aggancio Flex MOVING DETAIL

Per posizionare il diffusore AIRPLAK nella giusta posizione allentare la vite centrale dell'Aggancio Flex e far scorrere orizzontalmente il braccetto lungo l'asse dell'AIRPLAK. Una volta individuata la distanza ottimale riavvitare la vite.

*To position the AIRPLAK diffuser in the right position, loosen the central screw of the Aggancio Flex and horizontally scroll the arm along the axis of the AIRPLAK. Once you have identified the optimal distance tighten the screw.*

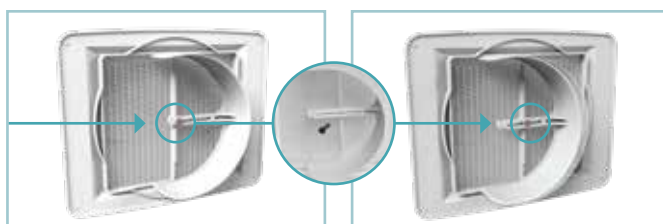

IT

Le nostre griglie sono dotate di Aggancio Flex, una innovativa molla ad imbocco elastico a geometria variabile per un montaggio rapido e stabile in fori o tubi di diametri diversi.

EN

Our gratings are equipped with Aggancio Flex, an innovative spring with an elastic mouth of variable geometry for fast and stable mounting in holes or tubes of different diameters.

**AGGANCI FLEX PER AIRPLAK**  
AGGANCI FLEX FOR AIRPLAK



**AGGANCI FLEX PER GRIGLIE**  
AGGANCI FLEX FOR GRATINGS



**AGGANCI FLEX PER ESALATORI 115**  
AGGANCI FLEX FOR VENT 115



**La gamma aggancio flex**  
*The aggancio flex range*



Ø 80/100 mm



Ø 100/125 mm



Ø 125/160 mm



Ø 160/200 mm

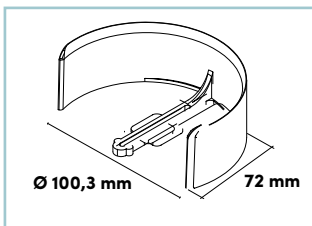

Ø 100,3 mm 72 mm

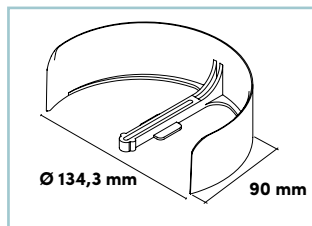

Ø 134,3 mm 90 mm

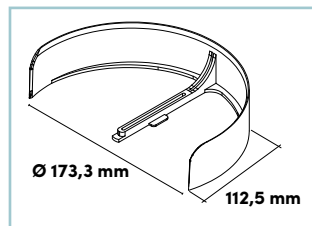

Ø 173,3 mm 112,5 mm

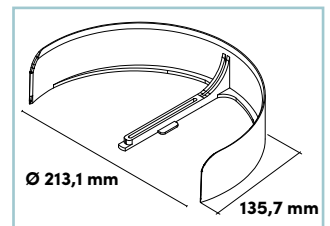

Ø 213,1 mm 135,7 mm

# VANTAGGI DI POSA

## ADVANTAGES OF INSTALLATION



IT

Le griglie in plastica dotate dell'innovativo Aggancio Flex, costituiscono una soluzione efficace che va a sostituire sia le griglie con imbocco a diametro fisso che quelle con molle metalliche, comunemente commercializzate.

L'Aggancio Flex:

- Consente una rapida e facile installazione della griglia al tubo con una immediata stabilità ed aderenza al muro dovuta alla profondità della molla ad imbocco che è di 40 mm. Inoltre consente una facile rotazione della griglia per un immediato orientamento delle alette.
- Consente una facile applicazione anche ai fori effettuati su mattoni forati, fori sbrecciati ed irregolari o senza tubo.
- Consente l'installazione e la stabilità della griglia anche in pannelli in cartongesso di soli 15 mm senza danneggiarli in fase di smontaggio (le molle tradizionali non riuscirebbero ad agganciarsi perché cadrebbero nel vuoto).
- Facilita la rimozione ed il reinserimento della griglia per le ispezioni periodiche in tutta sicurezza senza potersi ferire o tagliare come potrebbe succedere con molle metalliche.
- Non arrugginisce.

EN

*The plastic gratings equipped with the innovative Aggancio Flex, constitute an effective solution that replaces both the commonly marketed gratings with fixed inlet diameters as well as those with metal springs.*

*The Aggancio Flex:*

- *Allows for quick and easy installation of the grating to the tube with immediate stability and adherence to the wall due to the depth of the inlet to spring which is 40 mm. It also allows easy rotation of the grating for an immediate orientation of the fins.*
- *Allows easy application even to the holes made on hollow bricks, chipped and irregular holes or without tubes.*
- *Allows the installation and the stability of the grating even in plasterboard panels of only 15 mm without damaging them during disassembly (the traditional springs would not be able to hook on because they would fall into the empty space).*
- *Facilitates the removal and reinsertion of the grating for periodic safety inspections without being able to injure or cut as could happen with metal springs.*
- *Does not rust.*





Nella sequenza di esempio è rappresentato il caso di un foro per l'impianto di aspirazione realizzato in posizione critica, troppo a ridosso dell'angolo del muro e con griglia circolare tagliata per poter esser installata.

*In the sequence example is the case of a hole for the air intake system realized in a critical position, too close to the angle of the wall and with round grating cut to be installed.*



Posizionare l'Aggancio Flex alla distanza necessaria riavvitando parzialmente la vite per configurare la posizione desiderata.

*Place the Aggancio Flex at the required distance, partially screwing the screw to configure the desired position.*



Se necessario ruotare l'Aggancio Flex fino a raggiungere la corretta posizione e stringere la vite per bloccare il movimento.

*If necessary, rotate the Aggancio Flex until it reaches the correct position and tighten the screw to lock the movement.*

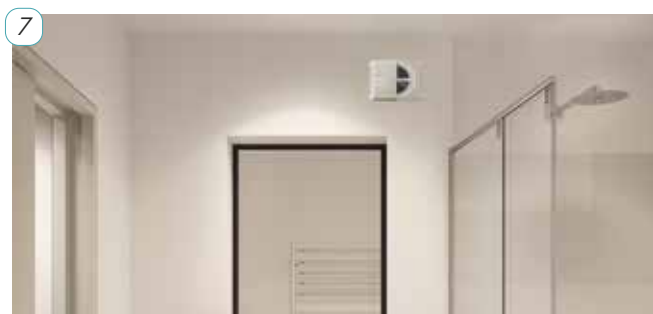

Dettaglio del posizionamento dell'Aggancio Flex nel foro.  
*Detail of the placement of the Aggancio Flex into the hole.*



In casi come questo Aggancio Flex si presta a realizzare un montaggio a regola d'arte della griglia: è sufficiente allentare la vite centrale e far scorrere orizzontalmente il braccetto dell'Aggancio Flex lungo l'asse dell'AIRPLAK.

*In cases like this Aggancio Flex lends itself to realize a state of the art mounting of the grating: it is sufficient to loosen the central screw and scroll horizontally to the arm of the Aggancio Flex along the axis of the AIRPLAK.*



Con la vite parzialmente avvitata se necessario iniziare a ruotare l'Aggancio Flex.

*With the screw partially tightened, if necessary, begin to rotate the Aggancio Flex.*



Inserire l'AIRPLAK nel foro.  
*Insert the AIRPLAK into the hole.*

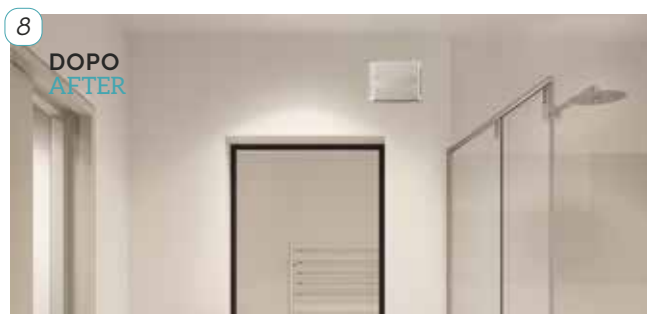

Montaggio concluso: applicazione del diffusore AIRPLAK eseguito a regola d'arte.

*Mounting concluded: application of the AIRPLAK diffuser done to perfection.*

# GRIGLIE

## GRATINGS

PATENTED

IT

Griglia realizzata in materiale plastico ABS con separatore laterale di flusso d'aria, concepito per evitare il fastidioso flusso d'aria frontale, disponibile in 3 modelli: circolare di diametro 115 e 175 mm e in forma quadrata di misura 180x180 mm. Disponibile nei colori bianco, beige e rame.

EN

Grating made of ABS plastic material with lateral separator airflow, conceived to avoid annoying frontal air flow, available in three models: circular with a diameter of 115 and 175 mm and in a square shape measuring 180x180 mm. Available in white, beige and copper.

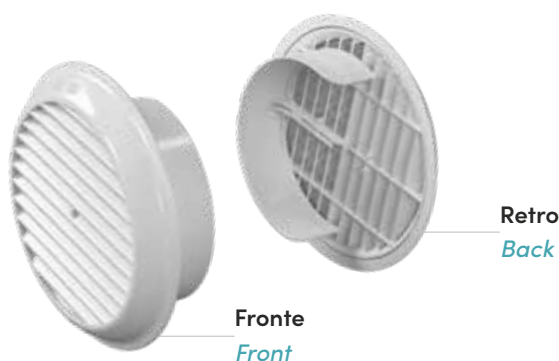

## VANTAGGI

### ADVANTAGES

- Materia prima ad alta performance
  - Semplice da installare
  - Corredata da separatore laterale di flusso
  - Corredata da rete antinsetti
  - Corredata da alette anti-pioggia
- High performance raw materials
  - Easy to install
  - Accompanied by lateral flow separator
  - Accompanied by insect net
  - Accompanied by rain flaps

A RICHIESTA COLORI DISPONIBILI:  
OPTIONAL COLOURS AVAILABLE:

Bianco  
White



Beige  
Beige

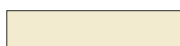

Rame  
Copper

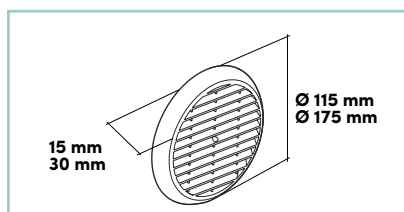

**Griglia ø115 con aggancio flex 80/100**  
**Grating ø115 with aggancio flex 80/100**

Fronte  
Front

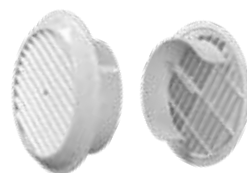

Retro  
Back

CODICE CODE	TIPO TYPE	COLORE COLOUR	DIAMETRO DIAMETER	SPESSORE THICKNESS	PASS. ARIA AIR PASSAGE	PAG LISTINO PRICE LIST PAGE	PZ 
P210100105	GRIGLIA 115 con Aggancio Flex 80/100	Bianco / <i>White</i>	Ø 115 mm	15 mm	cm <sup>2</sup> 40	22	1
P210100106	GRIGLIA 115 con Aggancio Flex 80/100	Beige / <i>Beige</i>	Ø 115 mm	15 mm	cm <sup>2</sup> 40	22	1
P210100107	GRIGLIA 115 con Aggancio Flex 80/100	Rame / <i>Copper</i>	Ø 115 mm	15 mm	cm <sup>2</sup> 40	22	1

**Griglia ø175 con aggancio flex 100/125**  
**Grating ø175 with aggancio flex 100/125**

Fronte  
Front

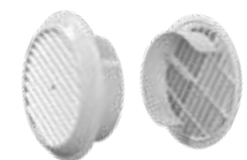

Retro  
Back

CODICE CODE	TIPO TYPE	COLORE COLOUR	DIAMETRO DIAMETER	SPESSORE THICKNESS	PASS. ARIA AIR PASSAGE	PAG LISTINO PRICE LIST PAGE	PZ 
P210100172	GRIGLIA 175 con Aggancio Flex 100/125	Bianco / <i>White</i>	Ø 175 mm	30 mm	cm <sup>2</sup> 100	22	1
P210100173	GRIGLIA 175 con Aggancio Flex 100/125	Beige / <i>Beige</i>	Ø 175 mm	30 mm	cm <sup>2</sup> 100	22	1
P210100174	GRIGLIA 175 con Aggancio Flex 100/125	Rame / <i>Copper</i>	Ø 175 mm	30 mm	cm <sup>2</sup> 100	22	1

**Griglia ø175 con aggancio flex 125/160**  
**Grating ø175 with aggancio flex 125/160**

Fronte  
Front



Retro  
Back

CODICE CODE	TIPO TYPE	COLORE COLOUR	DIAMETRO DIAMETER	SPESSORE THICKNESS	PASS. ARIA AIR PASSAGE	PAG LISTINO PRICE LIST PAGE	PZ 
P210100175	GRIGLIA 175 con Aggancio Flex 125/160	Bianco / <i>White</i>	Ø 175 mm	30 mm	cm <sup>2</sup> 100	22	1
P210100176	GRIGLIA 175 con Aggancio Flex 125/160	Beige / <i>Beige</i>	Ø 175 mm	30 mm	cm <sup>2</sup> 100	22	1
P210100177	GRIGLIA 175 con Aggancio Flex 125/160	Rame / <i>Copper</i>	Ø 175 mm	30 mm	cm <sup>2</sup> 100	22	1

**Griglia ø175 con imbocco circolare per tubi ø160**  
**Grating ø175 with circular inlet for tubes ø160**

Fronte  
Front



Retro  
Back

CODICE CODE	TIPO TYPE	COLORE COLOUR	DIAMETRO DIAMETER	SPESSORE THICKNESS	PASS. ARIA AIR PASSAGE	PAG LISTINO PRICE LIST PAGE	PZ 
P210100178	GRIGLIA 175 con imbocco Ø160	Bianco / <i>White</i>	Ø 175 mm	30 mm	cm <sup>2</sup> 100	22	1
P210100179	GRIGLIA 175 con imbocco Ø160	Beige / <i>Beige</i>	Ø 175 mm	30 mm	cm <sup>2</sup> 100	22	1
P210100180	GRIGLIA 175 con imbocco Ø160	Rame / <i>Copper</i>	Ø 175 mm	30 mm	cm <sup>2</sup> 100	22	1

A RICHIESTA COLORI DISPONIBILI:  
OPTIONAL COLOURS AVAILABLE:

Bianco  
*White*

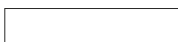

Beige  
*Beige*

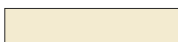

Rame  
*Copper*

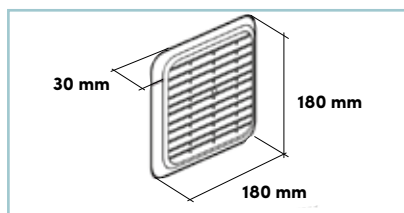

**Griglia quadrata 180x180 con aggancio flex 100/125**  
**Square grating 180x180 with aggancio flex 100/125**

Fronte  
*Front*



Retro  
*Back*

CODICE <i>CODE</i>	TIPO <i>TYPE</i>	COLORE <i>COLOUR</i>	SPESSORE <i>THICKNESS</i>	MISURA <i>SIZE</i>	PASS. ARIA <i>AIR PASSAGE</i>	PAG LISTINO <i>PRICE LIST PAGE</i>	PZ 
P210100162	GRIGLIA QUADRATA 180X180 con Aggancio Flex 100/125	Bianco / <i>White</i>	30 mm	180x180 mm	cm <sup>2</sup> 120	23	1
P210100163	GRIGLIA QUADRATA 180X180 con Aggancio Flex 100/125	Beige / <i>Beige</i>	30 mm	180x180 mm	cm <sup>2</sup> 120	23	1
P210100164	GRIGLIA QUADRATA 180X180 con Aggancio Flex 100/125	Rame / <i>Copper</i>	30 mm	180x180 mm	cm <sup>2</sup> 120	23	1

**Griglia quadrata 180x180 con aggancio flex 125/160**  
**Square grating 180x180 with aggancio flex**

Fronte  
*Front*



Retro  
*Back*

CODICE <i>CODE</i>	TIPO <i>TYPE</i>	COLORE <i>COLOUR</i>	SPESSORE <i>THICKNESS</i>	MISURA <i>SIZE</i>	PASS. ARIA <i>AIR PASSAGE</i>	PAG LISTINO <i>PRICE LIST PAGE</i>	PZ 
P210100165	GRIGLIA QUADRATA 180x180 con Aggancio Flex 125/160	Bianco / <i>White</i>	30 mm	180x180 mm	cm <sup>2</sup> 120	23	1
P210100166	GRIGLIA QUADRATA 180x180 con Aggancio Flex 125/160	Beige / <i>Beige</i>	30 mm	180x180 mm	cm <sup>2</sup> 120	23	1
P210100167	GRIGLIA QUADRATA 180x180 con Aggancio Flex 125/160	Rame / <i>Copper</i>	30 mm	180x180 mm	cm <sup>2</sup> 120	23	1

**Griglia quadrata 180x180 con imbocco circolare per tubi ø160**  
**Square grating 180x180 with circular inlet for tubes ø160**

Fronte  
Front



Retro  
Back

<b>CODICE</b> CODE	<b>TIPO</b> TYPE	<b>COLORE</b> COLOUR	<b>SPESSORE</b> THICKNESS	<b>MISURA</b> SIZE	<b>PASS. ARIA</b> AIR PASSAGE	<b>PAG LISTINO</b> PRICE LIST PAGE	<b>PZ</b> 
P210100168	GRIGLIA QUADRATA 180x180 con imbocco Ø160	Bianco / <i>White</i>	30 mm	180x180 mm	cm <sup>2</sup> 120	23	1
P210100169	GRIGLIA QUADRATA 180x180 con imbocco Ø160	Beige / <i>Beige</i>	30 mm	180x180 mm	cm <sup>2</sup> 120	23	1
P210100170	GRIGLIA QUADRATA 180x180 con imbocco Ø160	Rame / <i>Copper</i>	30 mm	180x180 mm	cm <sup>2</sup> 120	23	1

# ESALATORE ANTIVENTO

## WINDPROOF VENT

**PATENTED**

IT

Gli Esalatori Antivento sono stati ideati per favorire l'espulsione dell'aria interna verso l'esterno anche in caso di vento contrario grazie alla sua speciale conformazione. Si applicano a tubi di diametro 80, 90, 100, 110, 120, 140, 150, 160 mm.

EN

The Windproof Vents have been designed to facilitate the indoor air expulsion to the outside even in cases of headwind thanks to its special conformation. They apply to tube diameters of 80, 90, 100, 110, 120, 140, 150, 160 mm.

## VANTAGGI

### ADVANTAGES

- Espulsione dell'aria anche con vento sfavorevole
- Praticità di posa
- Fornito di Aggancio Flex per fissaggio rapido
- Rete antinsetti

- Expulsion of air even with unfavourable wind
- Easy installation
- Supplied with Aggancio Flex for fast attachment
- Anti-insect net

**Esalatore ø 115**  
**Con aggancio flex 80/100**  
**Windproof vent ø 115**  
**With aggancio flex 80/100**



ARCHIESTA COLORI  
 DISPONIBILI:  
 OPTIONAL COLOURS  
 AVAILABLE:

- Bianco / White
- Beige / Beige
- Rame / Copper

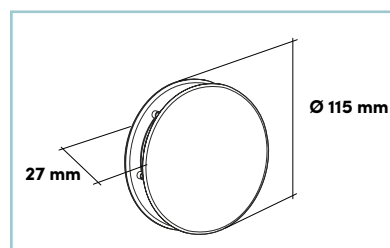

CODICE CODE	TIPO TYPE	COLORE COLOUR	DIAMETRO DIAMETER	SPESSORE THICKNESS	PASS. ARIA AIR PASSAGE	PAG. LISTINO PRICE LIST PAGE	PZ 
P210100310	ESALATORE 115 con Aggancio Flex 80/100	Bianco / White	Ø 115 mm	27 mm	cm <sup>2</sup> 40	24	1
P210100311	ESALATORE 115 con Aggancio Flex 80/100	Beige / Beige	Ø 115 mm	27 mm	cm <sup>2</sup> 40	24	1
P210100312	ESALATORE 115 con Aggancio Flex 80/100	Rame / Copper	Ø 115 mm	27 mm	cm <sup>2</sup> 40	24	1

68

ETERNO IVICA · VENT



**Esalatore ø 175**  
**Con aggancio flex 100/125**  
*Windproof vent ø 175*  
*With aggancio flex 100/125*



ARCHIESTA COLORI  
 DISPONIBILI:  
 OPTIONAL COLOURS  
 AVAILABLE:

Bianco / White  
 Beige / Beige  
 Rame / Copper

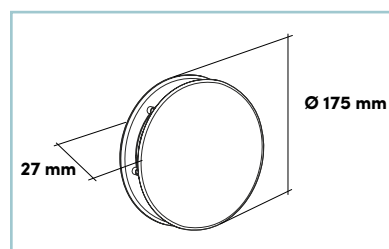

CODICE CODE	TIPO TYPE	COLORE COLOUR	DIAMETRO DIAMETER	SPESSORE THICKNESS	PASS. ARIA AIR PASSAGE	PAG LISTINO PRICE LIST PAGE	PZ 
P210100407	ESALATORE 175 con Aggancio Flex 100/125	Bianco / White	Ø 175 mm	27 mm	cm <sup>2</sup> 100	24	1
P210100408	ESALATORE 175 con Aggancio Flex 100/125	Beige / Beige	Ø 175 mm	27 mm	cm <sup>2</sup> 100	24	1
P210100409	ESALATORE 175 con Aggancio Flex 100/125	Rame / Copper	Ø 175 mm	27 mm	cm <sup>2</sup> 100	24	1

**Esalatore ø 175**  
**Con aggancio flex 125/160**  
*Windproof vent ø 175*  
*With aggancio flex 125/160*

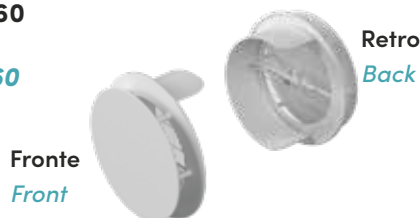

ARCHIESTA COLORI  
 DISPONIBILI:  
 OPTIONAL COLOURS  
 AVAILABLE:

Bianco / White  
 Beige / Beige  
 Rame / Copper

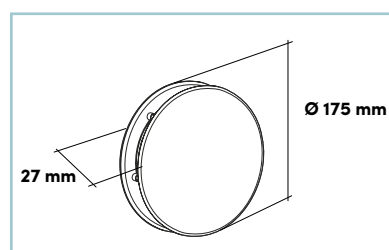

CODICE CODE	TIPO TYPE	COLORE COLOUR	DIAMETRO DIAMETER	SPESSORE THICKNESS	PASS. ARIA AIR PASSAGE	PAG LISTINO PRICE LIST PAGE	PZ 
P210100410	ESALATORE 175 con Aggancio Flex 125/160	Bianco / White	Ø 175 mm	27 mm	cm <sup>2</sup> 100	24	1
P210100411	ESALATORE 175 con Aggancio Flex 125/160	Beige / Beige	Ø 175 mm	27 mm	cm <sup>2</sup> 100	24	1
P210100412	ESALATORE 175 con Aggancio Flex 125/160	Rame / Copper	Ø 175 mm	27 mm	cm <sup>2</sup> 100	24	1

NB.: Esalatore antivento Ø 175 per cappa aspirante delle cucine

NB.: *Windproof Vent ø 175 for kitchen hood*

# AIRPLAK

## AIRPLAK

PATENTED

IT

Airplak è un diffusore d'aria perimetrale dal design innovativo ed elegante che garantisce un passaggio d'aria di 100 cm<sup>2</sup>. E' studiato per consentire un comfort abitativo elevato, poiché assicura una diffusione perimetrale dell'aria senza generare fastidiosi flussi diretti.

LA GAMMA AIRPLAK si sviluppa in 4 versioni: **AIRPLAK S**: versione standard - **AIRPLAK A**: con strato afonico - **AIRPLAK V**: con valvola autoregolante che si attiva per depressione con l'accensione della cappa aspirante - **AIRPLAK C**: con chiusura regolabile manualmente per flusso d'aria personalizzato

Ogni versione di AIRPLAK è disponibile in 4 diversi formati:

- AIRPLAK 40 = 220 x 105 x 30 mm
- AIRPLAK 70 = 175 x 160 x 30 mm
- AIRPLAK 100 = 220 x 175 x 30 mm
- AIRPLAK 200 = 220 x 224 x 30 mm

EN

*Airplak is a diffuser of perimeter air from the innovative and elegant design that guarantees a 100 cm<sup>2</sup> air passage. It's designed to allow a high level of comfort, as it ensures perimeter air diffusion without generating annoying direct air flows.*

*THE AIRPLAK RANGE is available in 4 versions: **AIRPLAK S**: standard version - **AIRPLAK A**: with soundproof layer - **AIRPLAK V**: with self-regulating valve that is activated by depression with the ignition of the range hood - **AIRPLAK C**: with manually adjustable closure for personalized air flow*

*Each version of AIRPLAK is available in 4 different sizes*

- AIRPLAK 40 = 220 x 105 x 30 mm*
- AIRPLAK 70 = 175 x 160 x 30 mm*
- AIRPLAK 100 = 220 x 175 x 30 mm*
- AIRPLAK 200 = 220 x 224 x 30 mm*

## VANTAGGI

### ADVANTAGES

- Comfort abitativo elevato
- Diffusione dell'aria senza flussi diretti
- Elegante, dal design ricercato
- Tante possibilità di configurazione
- Disponibile in diversi formati
- High living comfort
- Air diffusion without direct air flows
- Elegant, sophisticated design
- Many configuration possibilities
- Available in different sizes

70

ETERNO IVICA · VENT







**STANDARD S** = 1 + 5 + 6  
**AFONICA A** = 1 + 3 + 5 + 6  
**VALVOLA V** = 1 + 4 + 5 + 6  
**CHIUSURA C** = 1 + 2 + 5 + 6

**STANDARD S** = 1 + 5 + 6  
**SOUNDPROOF A** = 1 + 3 + 5 + 6  
**VALVE V** = 1 + 4 + 5 + 6  
**CLOSING C** = 1 + 2 + 5 + 6

ARCHIESTA COLORI DISPONIBILI:  
 OPTIONAL COLOURS AVAILABLE:

Bianco White	
Beige Beige	
Rame Copper	

① AIRPLAK FRONTE  
 AIRPLAK FRONT



② CHIUSURA  
 CLOSING



③ AFONICO  
 SOUNDPROOF



④ VALVOLA  
 VALVE



⑤ AIRPLAK RETRO  
 AIRPLAK BACK



⑥ AGGANCI FLEX  
 AGGANCI FLEX



**Airplak Standard 40**  
Con aggancio flex 80/100  
*Airplak Standard 40*  
With aggancio flex 80/100



ARCHIESTA COLORI  
DISPONIBILI:  
OPTIONAL COLOURS  
AVAILABLE:

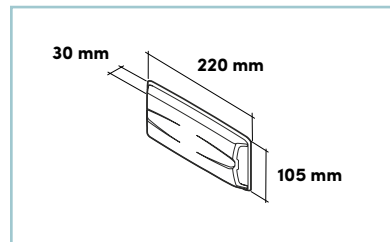

CODICE CODE	TIPO TYPE	COLORE COLOUR	MISURA SIZE	PASS. ARIA AIR PASSAGE	PAG LISTINO PRICE LIST PAGE	PZ 
P210101020	AIRPLAK 40 con Aggancio Flex 80/100	Bianco / White	220x105 mm	cm <sup>2</sup> 40	25	1
P210101023	AIRPLAK 40 con Aggancio Flex 80/100	Beige / Beige	220x105 mm	cm <sup>2</sup> 40	25	1

**Airplak Standard 70**  
Con aggancio flex 100/125  
*Airplak Standard 70*  
With aggancio flex 100/125

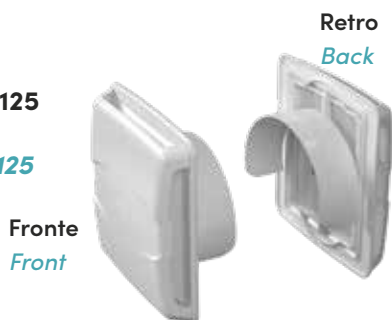

ARCHIESTA COLORI  
DISPONIBILI:  
OPTIONAL COLOURS  
AVAILABLE:

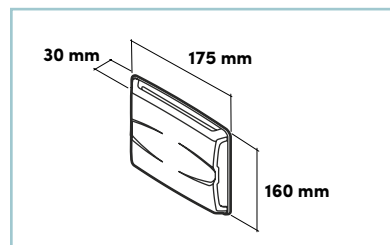
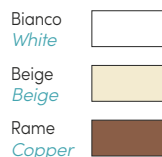



CODICE CODE	TIPO TYPE	COLORE COLOUR	MISURA SIZE	PASS. ARIA AIR PASSAGE	PAG LISTINO PRICE LIST PAGE	PZ 
P210101070	AIRPLAK 70 con Aggancio Flex 100/125	Bianco / White	175x160 mm	cm <sup>2</sup> 70	25	1
P210101073	AIRPLAK 70 con Aggancio Flex 100/125	Beige / Beige	175x160 mm	cm <sup>2</sup> 70	25	1
P210101076	AIRPLAK 70 con Aggancio Flex 100/125	Rame / Copper	175x160 mm	cm <sup>2</sup> 70	25	1

**Airplak Standard 100**  
**Con aggancio flex 125/160**  
*Airplak Standard 100*  
*With aggancio flex 125/160*

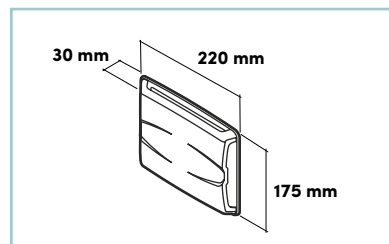
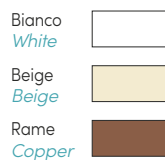

ARCHIESTA COLORI  
 DISPONIBILI:  
 OPTIONAL COLOURS  
 AVAILABLE:



CODICE CODE	TIPO TYPE	COLORE COLOUR	MISURA SIZE	PASS. ARIA AIR PASSAGE	PAG LISTINO PRICE LIST PAGE	PZ 
P210101000	AIRPLAK 100 con Aggancio Flex 125/160	Bianco / <i>White</i>	220x175 mm	cm <sup>2</sup> 100	25	1
P210101003	AIRPLAK 100 con Aggancio Flex 125/160	Beige / <i>Beige</i>	220x175 mm	cm <sup>2</sup> 100	25	1
P210101006	AIRPLAK 100 con Aggancio Flex 125/160	Rame / <i>Copper</i>	220x175 mm	cm <sup>2</sup> 100	25	1

**Airplak Standard 200**  
**Con aggancio flex 160/200**  
*Airplak Standard 200*  
*With aggancio flex 160/200*

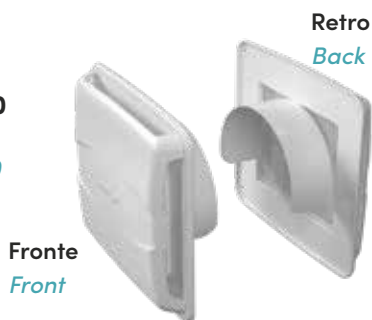

ARCHIESTA COLORI  
 DISPONIBILI:  
 OPTIONAL COLOURS  
 AVAILABLE:

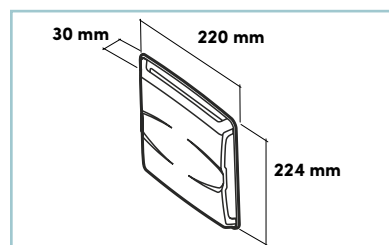

CODICE CODE	TIPO TYPE	COLORE COLOUR	MISURA SIZE	PASS. ARIA AIR PASSAGE	PAG LISTINO PRICE LIST PAGE	PZ 
P210101080	AIRPLAK 200 con Aggancio Flex 160/200	Bianco / <i>White</i>	220x224 mm	cm <sup>2</sup> 100	25	1
P210101083	AIRPLAK 200 con Aggancio Flex 160/200	Beige / <i>Beige</i>	220x224 mm	cm <sup>2</sup> 100	25	1
P210101086	AIRPLAK 200 con Aggancio Flex 160/200	Rame / <i>Copper</i>	220x224 mm	cm <sup>2</sup> 100	25	1

# AIRPLAK AFONICO A CON AGGANCIO FLEX

## AIRPLAK A SOUNDPROOF WITH AGGANCIO FLEX

**PATENTED**

### Airplak Afonico 40

Con aggancio flex 80/100\*  
Airplak A soundproof 40  
With aggancio flex 80/100\*



ARCHIESTA COLORI  
DISPONIBILI:  
OPTIONAL COLOURS  
AVAILABLE:

Bianco / White  
Beige / Beige

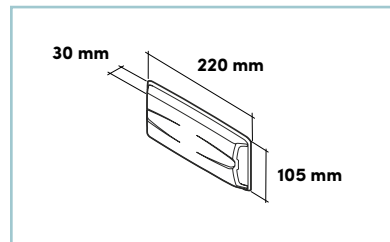

CODICE CODE	TIPO TYPE	COLORE COLOUR	MISURA SIZE	PASS. ARIA AIR PASSAGE	PAG LISTINO PRICE LIST PAGE	PZ 
P210401020	AIRPLAK 40 A con Aggancio Flex 80/100	Bianco / White	220x105 mm	cm <sup>2</sup> 40	26	1
P210401030	AIRPLAK 40 A con Aggancio Flex 80/100	Beige / Beige	220x105 mm	cm <sup>2</sup> 40	26	1

\* n.2 AIRPLAK 40 A: uno posizionato internamente all'abitazione e l'altro esternamente garantiscono un abbattimento acustico certificato di 38 dB

\* n.2 AIRPLAK 40 A: one positioned internally to the dwelling and the other one externally in order to guarantee a certified noise reduction of 38 dB

### Airplak Afonico 70

Con aggancio flex 100/125\*  
Airplak A soundproof 70  
With aggancio flex 100/125\*



ARCHIESTA COLORI  
DISPONIBILI:  
OPTIONAL COLOURS  
AVAILABLE:

Bianco / White  
Beige / Beige  
Rame / Copper

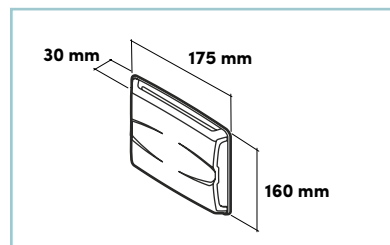

CODICE CODE	TIPO TYPE	COLORE COLOUR	MISURA SIZE	PASS. ARIA AIR PASSAGE	PAG LISTINO PRICE LIST PAGE	PZ 
P210402020	AIRPLAK 70 A con Aggancio Flex 100/125	Bianco / White	175x160 mm	cm <sup>2</sup> 70	26	1
P210402030	AIRPLAK 70 A con Aggancio Flex 100/125	Beige / Beige	175x160 mm	cm <sup>2</sup> 70	26	1
P210402040	AIRPLAK 70 A con Aggancio Flex 100/125	Rame / Copper	175x160 mm	cm <sup>2</sup> 70	26	1

\* n.2 AIRPLAK 70 A: uno posizionato internamente all'abitazione e l'altro esternamente garantiscono un abbattimento acustico certificato di 40 dB

\* n.2 AIRPLAK 70 A: one positioned internally to the dwelling and the other one externally in order to guarantee a certified noise reduction of 40 dB

**Airplak Afonico 100**  
**Con aggancio flex 125/160\***  
*Airplak A soundproof 100*  
**With aggancio flex 125/160\***



ARCHIESTA COLORI  
 DISPONIBILI:  
 OPTIONAL COLOURS  
 AVAILABLE:

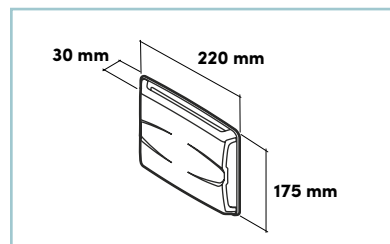
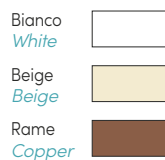

CODICE CODE	TIPO TYPE	COLORE COLOUR	MISURA SIZE	PASS. ARIA AIR PASSAGE	PAG LISTINO PRICE LIST PAGE	PZ 
P210403020	AIRPLAK 100 A con Aggancio Flex 125/160	Bianco / <i>White</i>	220x175 mm	cm <sup>2</sup> 100	26	1
P210403030	AIRPLAK 100 A con Aggancio Flex 125/160	Beige / <i>Beige</i>	220x175 mm	cm <sup>2</sup> 100	26	1
P210403040	AIRPLAK 100 A con Aggancio Flex 125/160	Rame / <i>Copper</i>	220x175 mm	cm <sup>2</sup> 100	26	1

\* n.2 AIRPLAK 100 A: uno posizionato internamente all'abitazione e l'altro esternamente garantiscono un abbattimento acustico certificato di 32 dB

\* n.2 AIRPLAK 100 A: one positioned internally to the dwelling and the other one externally in order to guarantee a certified noise reduction of 32 dB.

**Airplak Afonico 200**  
**Con aggancio flex 160/200\***  
*Airplak A soundproof 200*  
**With aggancio flex 160/200\***



ARCHIESTA COLORI  
 DISPONIBILI:  
 OPTIONAL COLOURS  
 AVAILABLE:

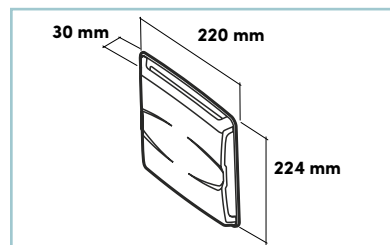

CODICE CODE	TIPO TYPE	COLORE COLOUR	MISURA SIZE	PASS. ARIA AIR PASSAGE	PAG LISTINO PRICE LIST PAGE	PZ 
P210404020	AIRPLAK 200 A con Aggancio Flex 160/200	Bianco / <i>White</i>	220x224 mm	cm <sup>2</sup> 100	27	1
P210404030	AIRPLAK 200 A con Aggancio Flex 160/200	Beige / <i>Beige</i>	220x224 mm	cm <sup>2</sup> 100	27	1
P210404040	AIRPLAK 200 A con Aggancio Flex 160/200	Rame / <i>Copper</i>	220x224 mm	cm <sup>2</sup> 100	27	1

\* n.2 AIRPLAK 100 A: uno posizionato internamente all'abitazione e l'altro esternamente garantiscono un abbattimento acustico certificato di 32 dB

\* n.2 AIRPLAK 100 A: one positioned internally to the dwelling and the other one externally in order to guarantee a certified noise reduction of 32 dB.

# AIRPLAK VALVOLA V CON AGGANCIO FLEX

## AIRPLAK VALVE V SOUNDPROOF WITH AGGANCIO FLEX

**PATENTED**

### Airplak Valvola 40

Con aggancio flex 80/100

### Airplak Valve 40

With aggancio flex 80/100



ARCHIESTA COLORI  
DISPONIBILI:  
OPTIONAL COLOURS  
AVAILABLE:

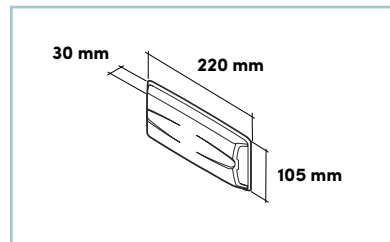

CODICE CODE	TIPO TYPE	COLORE COLOUR	MISURA SIZE	PASS. ARIA AIR PASSAGE	PAG LISTINO PRICE LIST PAGE	PZ 
P210301020	AIRPLAK 40 V con Aggancio Flex 80/100	Bianco / White	220x105 mm	da 0 a 40	27	1
P210301030	AIRPLAK 40 V con Aggancio Flex 80/100	Beige / Beige	220x105 mm	da 0 a 40	27	1

### Airplak Valvola 70

Con aggancio flex 100/125

### Airplak Valve 70

With aggancio flex 100/125



ARCHIESTA COLORI  
DISPONIBILI:  
OPTIONAL COLOURS  
AVAILABLE:

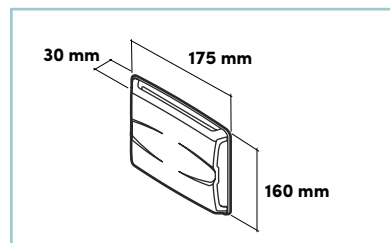



CODICE CODE	TIPO TYPE	COLORE COLOUR	MISURA SIZE	PASS. ARIA AIR PASSAGE	PAG LISTINO PRICE LIST PAGE	PZ 
P210302020	AIRPLAK 70 V con Aggancio Flex 100/125	Bianco / White	175x160 mm	da 0 a 70	27	1
P210302030	AIRPLAK 70 V con Aggancio Flex 100/125	Beige / Beige	175x160 mm	da 0 a 70	27	1
P210302040	AIRPLAK 70 V con Aggancio Flex 100/125	Rame / Copper	175x160 mm	da 0 a 70	27	1

**Airplak Valvola 100**  
**Con aggancio flex 125/160**  
*Airplak Valve 100*  
*With aggancio flex 125/160*

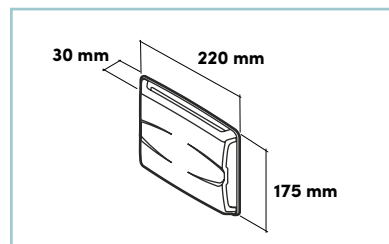
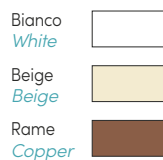

ARCHIESTA COLORI  
 DISPONIBILI:  
 OPTIONAL COLOURS  
 AVAILABLE:



CODICE CODE	TIPO TYPE	COLORE COLOUR	MISURA SIZE	PASS. ARIA AIR PASSAGE	PAG LISTINO PRICE LIST PAGE	PZ 
P210303020	AIRPLAK 100 A con Aggancio Flex 125/160	Bianco / <i>White</i>	220x175 mm	da 0 a 100	28	1
P210303030	AIRPLAK 100 A con Aggancio Flex 125/160	Beige / <i>Beige</i>	220x175 mm	da 0 a 100	28	1
P210303040	AIRPLAK 100 A con Aggancio Flex 125/160	Rame / <i>Copper</i>	220x175 mm	da 0 a 100	28	1

**Airplak Valvola 200**  
**Con aggancio flex 160/200**  
*Airplak Valve 200*  
*With aggancio flex 160/200*



ARCHIESTA COLORI  
 DISPONIBILI:  
 OPTIONAL COLOURS  
 AVAILABLE:

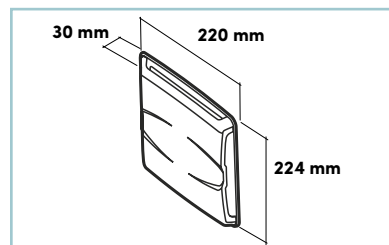

CODICE CODE	TIPO TYPE	COLORE COLOUR	MISURA SIZE	PASS. ARIA AIR PASSAGE	PAG LISTINO PRICE LIST PAGE	PZ 
P210304020	AIRPLAK 200 V con Aggancio Flex 160/200	Bianco / <i>White</i>	220x224 mm	da 0 a 100	28	1
P210304030	AIRPLAK 200 V con Aggancio Flex 160/200	Beige / <i>Beige</i>	220x224 mm	da 0 a 100	28	1
P210304040	AIRPLAK 200 V con Aggancio Flex 160/200	Rame / <i>Copper</i>	220x224 mm	da 0 a 100	28	1

**Airplak Chiusura 40**  
**Con aggancio flex 80/100**  
**Airplak Closing 40**  
**With aggancio flex 80/100**

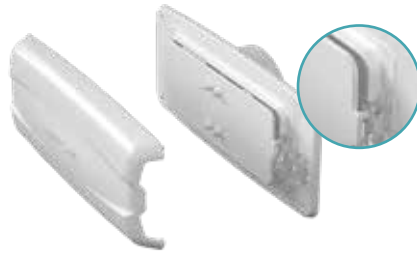

ARCHIESTA COLORI  
 DISPONIBILI:  
 OPTIONAL COLOURS  
 AVAILABLE:

- Bianco / White 
- Beige / Beige 

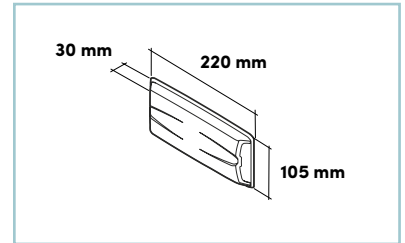

CODICE CODE	TIPO TYPE	COLORE COLOUR	MISURA SIZE	PASS. ARIA AIR PASSAGE	PAG LISTINO PRICE LIST PAGE	PZ 
P210201020	AIRPLAK 40 C con Aggancio Flex 80/100	Bianco / White	220x105 mm	da 0 a 40	28	1
P210201030	AIRPLAK 40 C con Aggancio Flex 80/100	Beige / Beige	220x105 mm	da 0 a 40	28	1

**Airplak Chiusura 70**  
**Con aggancio flex 100/125**  
**Airplak Closing 70**  
**With aggancio flex 100/125**



ARCHIESTA COLORI  
 DISPONIBILI:  
 OPTIONAL COLOURS  
 AVAILABLE:

- Bianco / White 
- Beige / Beige 
- Rame / Copper 

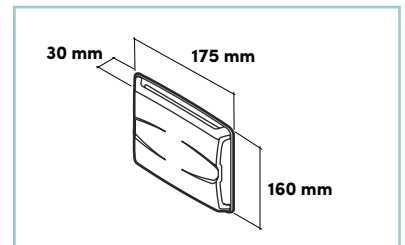

CODICE CODE	TIPO TYPE	COLORE COLOUR	MISURA SIZE	PASS. ARIA AIR PASSAGE	PAG LISTINO PRICE LIST PAGE	PZ 
P210202020	AIRPLAK 70 C con Aggancio Flex 100/125	Bianco / White	175x160 mm	da 0 a 70	29	1
P210202030	AIRPLAK 70 C con Aggancio Flex 100/125	Beige / Beige	175x160 mm	da 0 a 70	29	1
P210202040	AIRPLAK 70 C con Aggancio Flex 100/125	Rame / Copper	175x160 mm	da 0 a 70	29	1



**Airplak Chiusura 100**  
**Con aggancio flex 125/160**  
**Airplak Closing 100**  
**With aggancio flex 125/160**

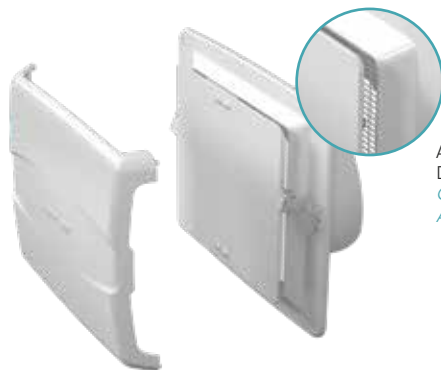

ARCHIESTA COLORI  
 DISPONIBILI:  
 OPTIONAL COLOURS  
 AVAILABLE:

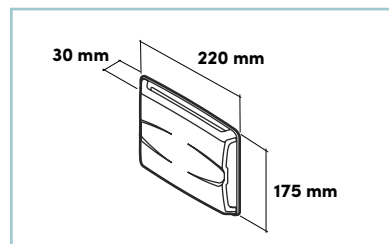
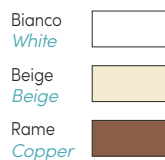

CODICE CODE	TIPO TYPE	COLORE COLOUR	MISURA SIZE	PASS. ARIA AIR PASSAGE	PAG LISTINO PRICE LIST PAGE	PZ 
P210101203	AIRPLAK 100 C con Aggancio Flex 125/160	Bianco / White	220x175 mm	da 0 a 100	29	1
P210101204	AIRPLAK 100 C con Aggancio Flex 125/160	Beige / Beige	220x175 mm	da 0 a 100	29	1
P210101205	AIRPLAK 100 C con Aggancio Flex 125/160	Rame / Copper	220x175 mm	da 0 a 100	29	1

**Airplak Chiusura 200**  
**Con aggancio flex 160/200**  
**Airplak Closing 200**  
**With aggancio flex 160/200**



ARCHIESTA COLORI  
 DISPONIBILI:  
 OPTIONAL COLOURS  
 AVAILABLE:

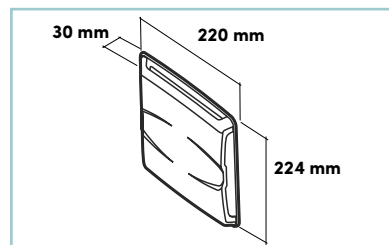

CODICE CODE	TIPO TYPE	COLORE COLOUR	MISURA SIZE	PASS. ARIA AIR PASSAGE	PAG LISTINO PRICE LIST PAGE	PZ 
P210203020	AIRPLAK 200 C con Aggancio Flex 160/200	Bianco / White	220x224 mm	da 0 a 100	29	1
P210203030	AIRPLAK 200 C con Aggancio Flex 160/200	Beige / Beige	220x224 mm	da 0 a 100	29	1
P210203040	AIRPLAK 200 C con Aggancio Flex 160/200	Rame / Copper	220x224 mm	da 0 a 100	29	1



MADE IN ITALY

**LICAV SRL**  
Via Casilina 1670  
001133 - Roma - Italy

+39 06 2053875

info@licav.it - www.licav.it